



VRC2000

*Installation and
Operations Manual*

*Copyright
Information* ≡

© Copyright 1997 Gentner Communications Corporation. All rights reserved. No part of this manual may be reproduced in any form or by any means without written permission from Gentner Communications Corporation. Printed in the United States of America. Original version, 11/89. Gentner Communications Corporation reserves specification privileges. Information in this manual is subject to change without notice.

VRC2000 Installation and Operations Manual

Gentner Part No. 800-072-200 (Rev. 2.00)

April 1997

Manual Development: Bill Kilpack

Artwork and Illustrations: Jim Wright, Bill Kilpack



Gentner Communications Corporation is committed to protecting the environment and preserving our natural resources.

This manual has been printed entirely on recycled paper.

Contents

Introduction	1
Warranty Registration	1
Unpacking	2
Features and Benefits	2
Product Description	2
Front-Panel Controls	4
Back-Panel Connectors	4
Remote/Local Modes	5
Before You Install	6
Power Requirements	6
Software Requirements	6
Telephone Line Requirements	6
Equipment Placement	6
Telephone Option	6
Initialization	6
Step 1 — Operating Voltage	6
Step 2 — Internal Lithium Battery	7
Step 3 — Surge Protection Option	7
Step 4 — Back-Panel Connections	7
Step 5 — Power Up	8
Operational Modes	9
Local vs. Remote Modes	9
Setup Modes	9
User Modes	9
Operator Mode	9
Automatic Mode	9
Tutorial	9
VRC2000 Setup	10
VRC2000 Word List	10
VRC2000 Setup and User Modes	11
Security	11
Changing Access Codes	12
Internal Battery/Access Code Check	14
Turning the VRC2000 Voice On/Off	15
Toggling Between User and Setup Modes	16
Changing the System Identifier	16
Setting the Clock	18
Clock Setting Exercise	19
Telephone Interface	20
Telephone Interface Setting Exercise	20
Setting Up Outbound Telephone Numbers	21
Telephone Number Programming Exercise	24
Alarms	26
Programming VRC2000 Alarm Delays and Channels	27
Setting Up Status Channels	27
Status Channel Programming Exercise	31
Metering Channels	36
Calibration Constant and Tolerance Limits	38

Contents continued

Setting Up Metering Channels	39
Metering Channel Programming Exercise	43
Setting Up Command Channels	50
Command Channel Programming Exercise	52
Setting Time-Of-Day Functions	54
Entering Time/Date On Time-Of-Day Functions	55
Time-Of-Day Function Programming Exercise	56
Setting Up Mute Functions	59
Mute Function Programming Exercise	60
Setting Up Sequence Output Programs	62
Sequence Output Programming Exercise	62
Setting Up Auto-Logging Functions	64
Auto-Logging Programming Exercise	65
Clearing All Programming	67
VRC2000 Installation	68
Step 1 — Determine Metering Channel Input Type	68
Step 2 — Metering Connections	69
Step 3 — Determine Status-Channel Input Range	69
Step 4 — Status Connections	70
Step 5 — Command Connections	70
Step 6 — Telephone Interface Connection	72
Step 7 — Four-Wire Connections (Dedicated Circuits)	72
Step 8 — Two-Way Radio Connection	73
Operation	74
Accessing User Mode	74
Taking Readings From Status and Metering Channels	74
Single/Multiple Responses From Status/Metering Channels	75
Issuing Commands	76
Remembering VRC2000 Codes	78
Alarms	78
Checking Current Date and Time	80
Using Sequence Output Programs	80
Using the Sound Sensor	81
Turning the Data Interface ON/OFF	81
Auto-Logging	82
Maintenance and Service	83
General Treatment	83
Troubleshooting	83
Frequently Asked Questions	87
Specifications	90
Firmware License	91
Warranty	92
FCC Part 15 Compliance	92
FCC Part 68 Compliance	93
U.S. Patent Information	93

Appendix A: Glossary	94
Appendix B: Connector Pinouts	98
Appendix C: Accessories	100
Software	100
Hardware	101
Appendix D: Theory of Operation	102
Microcontroller Theory	103
Telephone Logic and Interface	104
Unbalanced Audio Output	105
Status Channel Inputs	105
Metering Channel Inputs	105
Command Channel Outputs	106
Real-Time Clock	106
DTMF Encoder/Decoder	106
Digital Voice Synthesizer	107
Power Supply	107
Appendix E: Technical Description	108
VRC2000 Unit	108
Real-Time Clock and Memory	108
Inputs	108
Appendix F: Remote/Local Tutorial	110
Local Mode	110
Remote Mode	113
Appendix G: Time-Of-Day Function Tutorial	114
Exercise 1	114
Exercise 2	116
Exercise 3	116
Appendix H: Setup Worksheets	117
Worksheet 1: Auto-Logging	117
Worksheet 2: Real-Time Clock/Calendar	117
Worksheet 3: Telephone Interface Options Setup	117
Worksheet 4: System Identifier Setup	118
Worksheet 5: Access Codes Setup	118
Worksheet 6: Outbound Telephone Numbers	119
Worksheet 7: Sequence-Output Programs	119
Worksheet 8: Time-Of-Day Functions Setup	120
Worksheet 9: Mute Assignments	121
Worksheet 10: Command Channel Setup	122
Worksheet 11: Metering Channel Setup	123
Worksheet 12: Status Channel Setup	124
Appendix I: Word List	125
Appendix J: Schematics	129

List of Figures

Figure 1.	Equipment diagram	2
Figure 2.	Typical VRC2000 configuration	3
Figure 3.	VRC2000 front-panel controls	4
Figure 4.	VRC2000 back-panel connectors	4
Figure 5.	VRC2000 transformer wiring diagram	7
Figure 6.	VRC2000 lithium battery jumper diagram	7
Figure 7.	VRC2000 back-panel connectors	7
Figure 7a.	VRC2000 back-panel connectors	8
Figure 8.	Power-up configuration	8
Figure 9.	VRC2000 front-panel controls	9
Figure 10.	Operational Modes	9
Figure 11.	VRC2000 front-panel controls	12
Figure 11a.	VRC2000 front-panel controls	14
Figure 12.	Telephone configuration quick reference	25
Figure 13.	VRC2000 metering-channel input conversion	68
Figure 14.	VRC2000 back-panel connectors	69
Figure 15.	VRC2000 metering-channel input schematic	69
Figure 16.	VRC2000 status-channel input, series diode inserted	69
Figure 17.	Status-channel surge protection	69
Figure 18.	VRC2000 back-panel connectors	70
Figure 19.	VRC2000 status-channel input schematic	70
Figure 20.	VRC2000 command-channel input schematic	71
Figure 21.	VRC2000-to-Command Relay Unit schematic	71
Figure 22.	VRC2000 back-panel connectors	72
Figure 23.	DTMF keypad	78
Figure 24.	Receive amplifier schematic	84
Figure 25.	RFI filter.	85
Figure 26.	Microphone amplifier schematic	86
Figure 27.	VRC2000 block diagram	102
Figure 28.	VRC2000 front-panel controls	110

List of Tables

Table 1.	System Identifier Word List	17
Table 2.	Clock/Calendar Setting Exercise	19
Table 3.	Telephone Interface Setting Exercise	21
Table 4.	Telephone Number Programming Exercise	24
Table 5.	Pager Number Programming Exercise	26
Table 6.	Outbound Telephone Number Command Codes	26
Table 7.	Status Channel Access Codes	31
Table 8.	Metering Channel Access Codes	42
Table 9.	Command Channel Access Codes	52
Table 10.	Time-Of-Day Function Access Codes	55
Table 11.	Mute Function Access Codes	60
Table 12.	Sequence Output Programming Exercise	63
Table 13.	Sequence-Output Program Access Codes	63
Table 14.	Sequence Output Access Codes	81
Table 15.	Command 1–8 Pinout	98
Table 16.	Command 9–16 Pinout	99
Table 17.	Metering Pinout	99
Table 18.	Status Pinout	100
Table 19.	VRC2000 Chip-Enable Logic	103
Table 20.	Hardware Interrupt Prioritization	104

Introduction 

Congratulations on purchasing the VRC2000 Voice Remote Control. The VRC2000 is a very flexible remote control system. It can be set up to efficiently and effectively monitor a wide variety of remote equipment, including broadcast transmitters.

The VRC2000's built-in voice synthesizer allows the unit to talk over any standard dial-up telephone line in plain English, providing complete control over your remote location from anywhere there is a telephone. The VRC2000 responds to commands sent by any standard touch-tone telephone. Other types of control interfaces are optionally available, including a two-way radio interface and modem connections for PCs.

The VRC2000 system allows you to define the characteristics of each monitor/control channel. You program the voice synthesizer to give you the information you need; you may also program the VRC2000 to act on its own when certain conditions are met, including calling you to report alarm conditions.

This manual explains how to install, set up and operate the VRC2000 in a step-by-step format. It also supplies instructions on how to resolve technical problems, should any arise.

If you need any additional information on how to install, set up or operate your system, please contact us at Gentner Communications at the location noted below. We welcome and encourage your comments so we can continue to improve our products and serve your needs.

Gentner Communications Corporation

1825 Research Way
Salt Lake City, UT 84119

TEL: Worldwide 801.975.7200 In U.S.A. 800.945.7730

FAX: Worldwide 801.977.0087 In U.S.A. 800.933.5107

FAX-On-Demand 24-Hour Information Service 800.695.8110

FAX-On-Demand International Line 801.974.3661

Worldwide Web Page @ <http://www.gentner.com>

Warranty Registration

Please register your VRC2000 by completing the self-addressed, postage prepaid warranty registration card and return it to Gentner Communications by mail. You may also FAX it to the above listed fax number or call Gentner Communications. When your product is properly registered, Gentner Communications will be able to serve you better should you require technical assistance or desire to receive upgrades, new product information, etc.

Unpacking

Ensure that the following items (See Figure 1, below.) were received with your shipment:

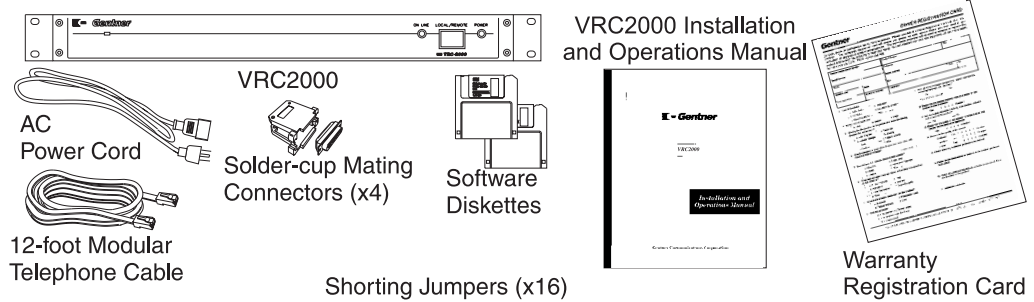

Figure 1. Equipment diagram

SHIPPING NOTE:

Gentner Communications is not responsible for product damage incurred during shipment. You must make claims directly with the carrier. Inspect your shipment carefully for obvious signs of damage. If the shipment appears to be damaged, retain the original boxes and packing material for inspection by the carrier. Contact your carrier immediately.

Features and Benefits

- Direct access to all monitoring and control functions from any DTMF telephone or PC
- Multilevel security to prevent unauthorized access to your system
- Precise meter readings for 16 parameters of your remote site (each channel configurable for up to four tolerance limits)
- Monitor the On/Off status of up to 16 remote-site parameters
- Remote control of up to 16 command channels (each with two switches), programmable to latching or momentary
- Automatic reporting of alarm conditions
- Automatic control of critical functions, activated by status or metering channel alarm condition or regularly scheduled time
- Customizable synthesized voice reporting (vocabulary of almost 800 words)
- VRC2000 control unit required only at the remote location

Product Description

The VRC2000's flexible systemic architecture allows it to efficiently and effectively monitor a wide variety of remote equipment (i.e. broadcast transmitters). The VRC2000's built-in voice synthesizer provides complete control over your remote location from anywhere there is a telephone.

The VRC2000 responds to commands that you send with any standard DTMF telephone. Other types of control interfaces are optionally available ([Appendix C: Accessories, Page 100](#)).

The VRC2000 system allows you to define the operational characteristics of each monitoring and control channel. You program the voice synthesizer to give you only the information you need from every important monitoring channel. You may also program the VRC2000 to act on its own when certain conditions are

met, such as having the VRC2000 call your telephone number to report alarm conditions.

The following block diagram (See Figure 2, below.) depicts a typical VRC2000 installation in a radio broadcast facility:

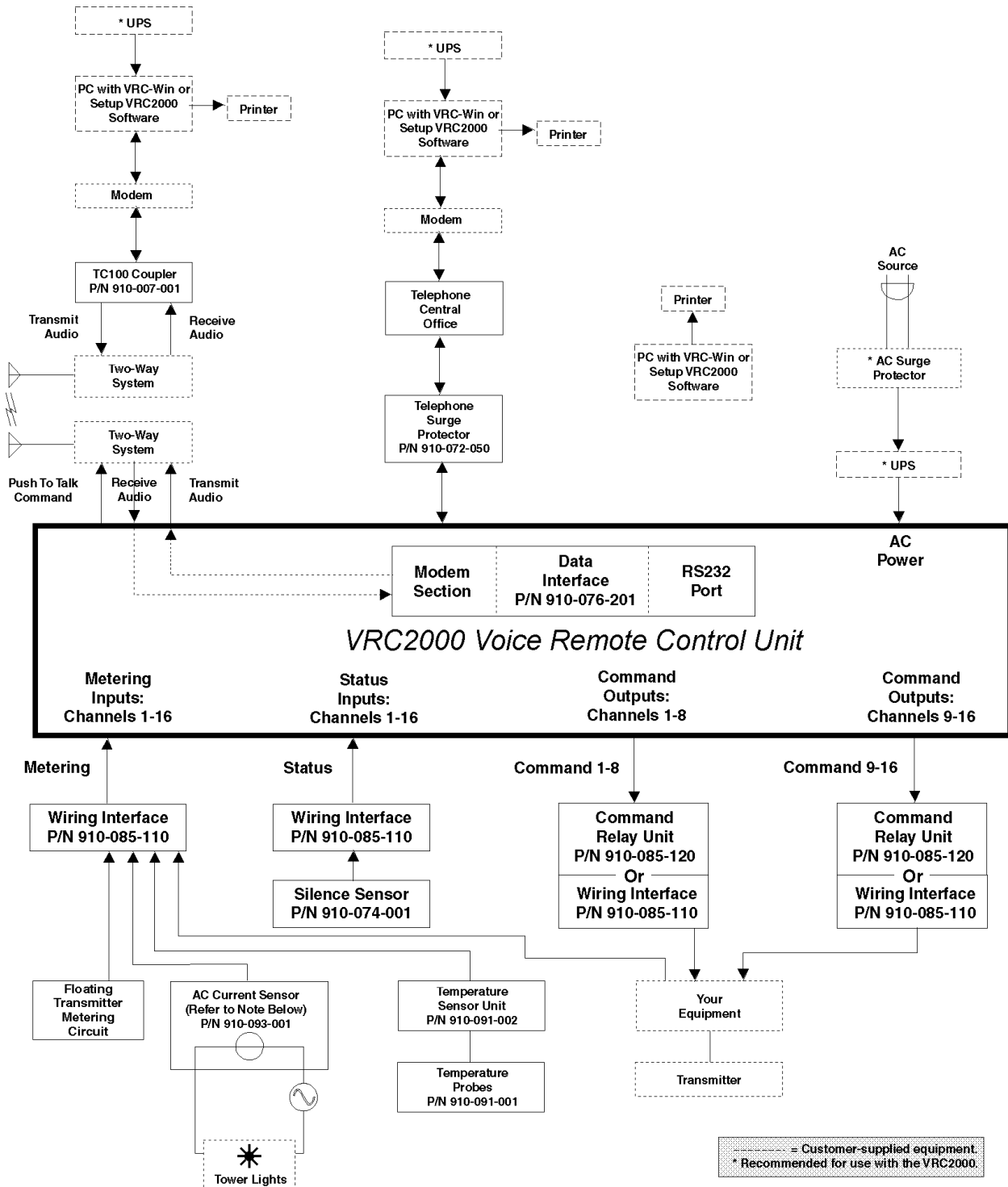

NOTE: AC Current Sensor allows accurate metering of tower lights. Can be used to determine how many lamps are still in service at a remote site and allows user to determine if beacon and markers are operating.

Figure 2. Typical VRC2000 configuration

This combination of power and flexibility allows you to use the VRC2000 in the following situations: main transmitter remote control, automatic transmission system operation, backup transmitter remote control, engineering remote control,

Product Description
Continued ≡

microwave remote supervision, machine remote control, land mobile repeater remote control, paging transmitter remote control, low-power TV (LPTV) remote control.

Front-Panel Controls

The VRC2000 unit was designed for ease in operation and physical hookup. Manual operation consists of a single button and two LEDs (Figure 3, below). The front-panel controls perform the following functions:

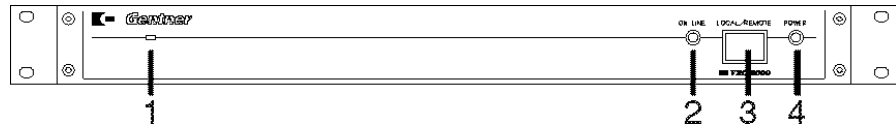

Figure 3. VRC2000 front-panel controls

1. *Condenser Microphone.* From this opening, dial-up callers can audibly monitor the surrounding area of the installed VRC2000 unit.
2. *On Line.* This LED indicates if the VRC2000 is coupled to the *telephone line in use* that is plugged into the back of the unit.
3. *Local/Remote.* This button toggles the VRC2000 between local control and remote operation via dial-up telephone line or using the VRC-Win software (Windows®) or Setup VRC2000 software (DOS).
4. *Power.* This LED indicates if power is being supplied to the VRC2000.

Back-Panel Connectors

Following are descriptions of each of the VRC2000's connectors (Figure 4, below). For pinouts, see Appendix B: Connector Pinouts (Page 98).

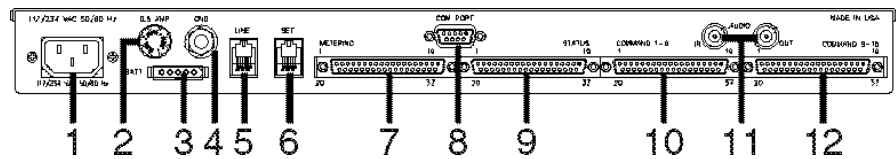

Figure 4. VRC2000 back-panel connectors

1. *Power.* The VRC2000 will operate with the AC input-voltage setting of 117Vac or 234Vac.

POWER NOTE:

You must verify that your VRC2000 is set to operate from the correct AC line voltage before plugging it in. See Initialization, Page 6.

2. *0.5 Amp.* This fuse module is where the half-amp fuse is located.
3. *Batt.* This connector is for connection of an optional battery backup. Gentner Communications recommends purchasing an Uninterruptible Power Supply (UPS).
4. *Gnd.* This ground lug is for connection of all equipment requiring grounding (such as the Gentner telephone surge protector).
5. *Line.* This RJ11C jack serves as the communication link between the VRC2000 and a standard dial-up telephone line.
6. *Set.* This RJ11C jack allows a telephone set to be connected to the VRC2000 to monitor incoming calls, place outbound calls or provide local

control (such as during setup; see VRC2000 Setup, [Page 10](#)).

7. *Metering.* This DB37 connector serves as the metering communication link between the VRC2000 and the site equipment.

8. *COM Port.* This DB9 connector serves as the serial link between the VRC2000 and a PC.

9. *Status.* This DB37 connector serves as the status communication link between the VRC2000 and the site equipment.

10. *Command 1–8.* This DB37 connector serves as the command link (for the first eight command channels) between the VRC2000 and the site equipment.

11. *Audio In/Out.* These standard BNC connectors provide unbalanced, four-wire interconnection, such as for two-wire radio.

12. *Command 9–16.* This DB37 connector serves as the command link (for the second eight command channels) between the VRC2000 and the site equipment.

Remote/Local Modes

The standard mode of operation for the VRC2000 is remote mode. This allows users connected via dial-up telephone line to remotely control the VRC2000 and issue commands.

However, suppose that the site engineer needs to perform maintenance on site equipment. To do so, he must press the REMOTE/LOCAL button [3] ([See Figure 3, previous page.](#)) on the VRC2000's front panel (the button will light red, indicating that the VRC2000 is in local mode). In this mode, the VRC2000 is suspended from issuing command outputs, *unless issued by the DTMF telephone connected to the VRC2000's SET jack* [6] ([Figure 4, previous page.](#)) When in the local position, the VRC2000 provides direct current to the telephone set through the SET jack, allowing use of the DTMF pad to key in programming tones to set up the VRC2000. In other words, in local mode, the VRC2000 can be programmed or operated directly, without connecting through a dial-up telephone line. However, metering and status information is still available, as before.

REMOTE/LOCAL NOTE:

Switching the VRC2000 to local mode during maintenance of site equipment is critical. If the engineer was working on site equipment and the remote location evoked a command channel connected to the site equipment, the engineer could possibly be injured.

Before You
Install 

Power Requirements

The VRC2000 will accommodate an AC-voltage input of 117Vac or 234Vac (manual switching required), 50–60Hz, 15W nominal.

POWER NOTE:

You must verify that your VRC2000 is set to operate from the correct AC line voltage before plugging it in. See Installation, below.

Software Requirements

Refer to your Setup VRC2000 Installation and Operations Manual or VRC-Win Installation and Operations Manual.

Telephone Line Requirements

For normal operation, the VRC2000 works on standard analog telephone lines and connects to the telephone system with a standard RJ11C modular jack. If you do not have an RJ11C jack where you want to install your VRC2000, call your telephone company for installation.

Equipment Placement

The VRC2000 is designed for standard 19-inch rack-cabinet mounting.

Telephone Option

A DTMF telephone set can be used for local-mode control and programming of your VRC2000.

Initialization 

Before connecting the VRC2000 to your site equipment, it is necessary to initialize the unit to verify it is properly configured.

Step 1 — Operating Voltage

OPERATING VOLTAGE NOTE:

You must verify that your VRC2000 is set to operate from the correct AC line voltage before plugging it in.

Your VRC2000 may operate on either 117Vac or 234Vac. You must verify which operating voltage your VRC2000 is set for by looking at the wiring harness of the VRC2000's internal line transformer.

Unless marked otherwise, the VRC2000 is shipped with the harness jumpered for 117Vac. However, you should follow the procedure listed below to insure that your particular unit is properly set up before applying AC power to the system.

To change the VRC2000's operating voltage:

Step 1

Carefully remove the VRC2000's top cover by loosening the four mounting screws on the sides of the unit.

Step 2

Disconnect the four conductor Molex connections between the transformer

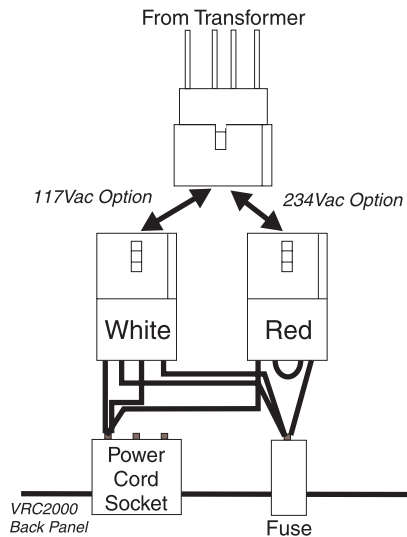

Figure 5. VRC2000 transformer wiring diagram

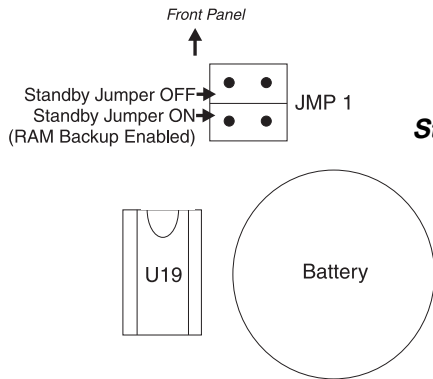

Figure 6. VRC2000 lithium battery jumper diagram

inputs and the power-cord connector.

Step 3

Insert the *white* Molex connector for 117Vac operation. Use the *red* Molex connector for 234Vac operation. (See Figure 5, left.)

Step 2 — Internal Lithium Battery

Properly connect the internal lithium battery to the system RAM and clock circuitry *before* applying power to your new VRC2000.

The internal lithium battery provides power to back up the system RAM and real-time clock. In order to extend the life of the battery, it is not connected at the factory. You must properly position a Berg shorting jumper (See Figure 6, left, below.) in order to connect the internal lithium battery.

BATTERY CONNECTION NOTE:

If you do not properly connect the internal lithium battery, all VRC2000 default programming will be restored in the event of an AC power failure or power bump. All custom programming will be lost.

Do not apply AC power until you have properly positioned the internal lithium battery jumper and checked the AC voltage set up for your VRC2000.

Step 3 — Surge Protection Option

The VRC2000 is a sensitive electronic device. In order to avoid damage to your unit, Gentner Communications strongly recommends that you *always* properly protect your VRC2000 from voltage surges over telephone lines and AC power lines connected to your VRC2000.

The VRC2000 is equipped with a highly reliable Telephone Surge Protector (See Appendix C: Accessories, Page 100.) on the telephone line input. Gentner Communications does not guarantee that this Telephone Surge Protector will protect your VRC2000 from damage caused by all voltage surges; however, the Telephone Surge Protector will help limit such damage.

VOLTAGE SURGE NOTE:

Never disconnect or bypass surge protection for your VRC2000. Damage to your VRC2000 system caused by voltage surges is not covered under the terms of the Gentner warranty agreement (Page 92).

Step 4 — Back-Panel Connections

Telephone Set

Connect a standard DTMF telephone set to the SET jack [6] (See Figure 7, below.) on the back panel of the VRC2000 with a standard modular cable.

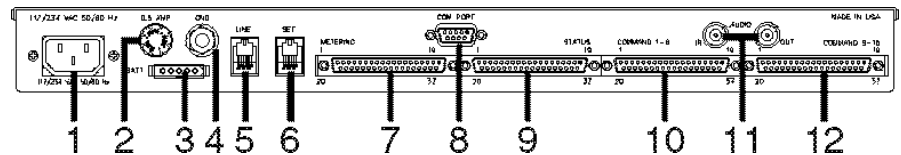

Figure 7. VRC2000 back-panel connectors

Telephone Line

Use the supplied modular telephone connector to connect the LINE jack [5] to the telephone line coming into your building.

Initialization
Continued

Figure 7a. VRC2000 back-panel connectors

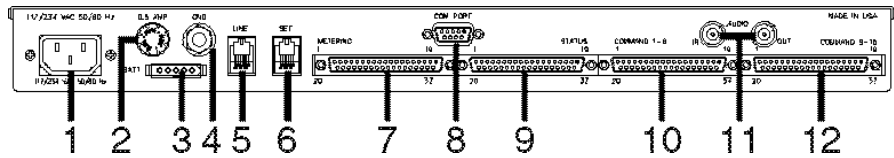

Audio Amplifier

If possible, attach an audio amplifier and speaker to the BNC connector marked AUDIO OUT [11] (Figure 7a, above).

Step 5 — Power Up

Connect the supplied AC power cord to the power module [1], and apply AC power to the VRC2000.

MANUAL NOTE:

In instances where the VRC2000 responds verbally, the VRC2000’s verbiage will be set off by a bullet (•) and printed in SMALL CAPS. Numbers and phrases you should send back to the VRC2000 with your DTMF keypad will be offset with a block (☐) and quotation marks (“ ”).

With Audio Amplifier

If you have an audio amplifier and speaker attached to the VRC2000 (See Figure 8, below.), the unit should respond with the spoken phrase:

- DATA ERASED. CLOCK ERASED.

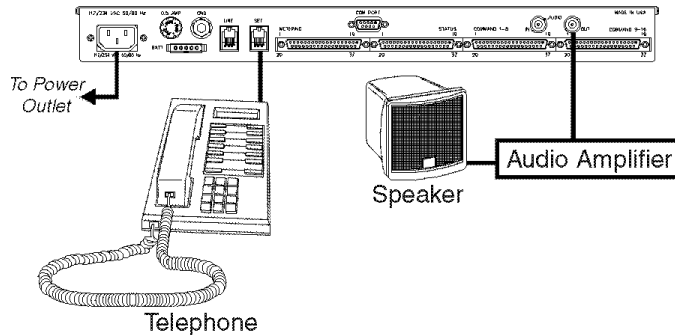

Figure 8. Power-up configuration

Now remove AC power from the VRC2000, and plug the unit back in. The VRC2000 should respond with the phrase

- DATA OK. CLOCK OK.

However, if the VRC2000 *also* responds

- DATA ERASED. CLOCK ERASED.

the internal lithium battery has not been properly connected. Perform Step 2 — Internal Lithium Battery (See Page 7.) again.

Without Audio Amplifier

If you do not use an audio amplifier to confirm that your VRC2000 is ready for operation, follow these directions:

- 1) Apply AC power to the VRC2000.
- 2) Pick up the telephone handset and listen.

3) Press the LOCAL/REMOTE button [3] on the VRC2000's front panel (Figure 9, below). The LOCAL/REMOTE button will light red and the VRC2000 should respond over the telephone handset:

- SETUP ENABLED. PLEASE ENTER SYSTEM ACCESS CODE.

Figure 9. VRC2000 front-panel controls

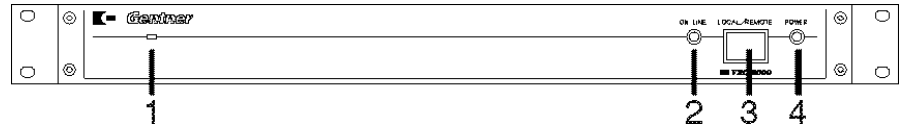

This verifies that the VRC2000 is properly set up and ready to accept programming. If you have problems obtaining the correct responses from the VRC2000, check all of your connections, and try again.

Do not proceed until your VRC2000 responds as noted above.

Operational Modes ≡

Once the VRC2000 is properly initialized, familiarize yourself with the unit's operation. The VRC2000 is an extremely flexible and powerful tool. Take the time you need to experiment with it so that you understand all of its available options and capabilities. Reading the VRC2000 Installation and Operations Manual now will save a lot of frustration and wasted time later.

VRC2000 Modes

- 1) Local Setup Mode
- 2) Local User Mode
- 3) Remote Setup Mode
- 4) Remote User Mode
- 5) Remote Operator Mode
- 6) Automatic (ATS) Mode

Figure 10. Operational Modes

The VRC2000 has six modes of operation (Figure 10, left).

Local vs. Remote Modes

The local modes (one and two) are used while on-site with the VRC2000. The remote modes (three through five) cover operation when connected to the VRC2000 over a dial-up telephone line, two-way radio, or via an auxiliary connection. Also see Remote/Local Modes (Page 5).

Setup Modes

Setup modes (one and three) allow you to verify or change any of the VRC2000's programmable functions.

User Modes

User modes (two and four) allow you to take readings from any metering or status channels, and activate command channels for your VRC2000.

Operator Mode

Operator mode (five) allows you take readings from any status or metering channel. From operator mode, commands cannot be issued.

Automatic Mode

Automatic (ATS) mode (six) is the normal operating mode of the VRC2000, when none of the other modes are being used.

Tutorial

For a brief tutorial of local and remote modes, refer to Appendix F: Remote/Local Tutorial (Page 110).

VRC2000
Setup 

The VRC2000 is controlled and set up with DTMF tones. You can use any standard DTMF telephone in either the local or remote modes to set up and program the VRC2000.

If you are unfamiliar with the VRC2000's operation and set-up procedures, read this section of the manual thoroughly. Experienced VRC2000 users may wish to refer to the setup worksheets in Appendix H: Setup Worksheets ([Page 117](#)).

The set-up process is fast and easy if you use the Setup VRC2000 software or VRC-Win software now available from Gentner Communications. These software packages will run on any 100-percent IBM-compatible PC that is equipped with a 100-percent Hayes-compatible modem. The Setup VRC2000 software is a menu-driven DOS-based program that greatly simplifies and speeds up this process. The VRC-Win software is Windows®-based, simplifying things further through the point-and-click user interface. These software are especially useful for owners who have never set up a VRC2000 before. Refer to Appendix C: Accessories ([Page 100](#)) for more information about the Setup VRC2000 software and VRC-Win software.

The set-up procedure will take substantial time if you plan to use a standard DTMF telephone. It is very important that you thoroughly understand the operation of the VRC2000 as well as the electrical parameters of the equipment you plan to control with the VRC2000 before you begin the set-up process. The better you understand the system and the more you plan ahead, the easier the set-up process will be.

Planning is vital to successful and error-free programming of the VRC2000. You can always change the parameters for any VRC2000 channel after you have set up the channel, but a little planning will help you make more efficient use of the set-up process.

Refer to the worksheets in Appendix H: Setup Worksheets ([Page 117](#)). Programming is straightforward if you use these worksheets, and have them in front of you while setting up your VRC2000.

MANUAL NOTE:

In instances where the VRC2000 responds verbally, the VRC2000's verbiage will be set off by a bullet (•) and printed in SMALL CAPS. Numbers and phrases you should send back to the VRC2000 with your DTMF keypad will be offset with a telephone icon (☎) and quotation marks (" ").

VRC2000 Word List

The VRC2000's special electronic speech package allows the system to talk in plain English to you over any dial-up telephone line. This speech package has a vocabulary of almost 800 words. The VRC2000 will say whatever is desired in response to commands, sign-ons, sign-offs, metering requests, etc.

For example

- HELLO. THIS IS THE AM TRANSMITTER. PLEASE ENTER ACCESS CODE.

Or the VRC2000 can respond to a particular command with

- COMMAND CHANNEL TWO. MAIN POWER, RAISE.

Or the VRC2000 can respond to a metering request with

- METERING CHANNEL ONE. FILAMENT VOLTAGE, 6.123 VOLTS.

These phrases are only examples. The VRC2000 is very flexible and, within the limits of the system's vocabulary, can be set up to say anything desired.

A complete listing of the VRC2000's vocabulary is included in Appendix I: Word List ([Page 125](#)).

VRC2000 Setup and User Modes

The VRC2000 has two major modes of operation: setup and user. The setup mode allows programming all functions of any metering, status or command channel, setting alarm parameters, specifying words and sentences for the VRC2000 to use, and several other functions. The user mode allows metering channel or status channel reports to be requested, and commands to be issued to change the operating parameters of the equipment connected to the unit. The VRC2000 can be accessed and operated in either the setup or the user mode from either a local or remote location.

The VRC2000 is designed for easy setup. With only the basic VRC2000 unit and a standard DTMF telephone, the functions of any metering, status or command channel can be programmed, as well as the unit's responses to any metering or status request, or command.

To set up the VRC2000 so all functions correspond with specific needs and applications, enter DTMF tones from a telephone pad to program any VRC2000 function. When a valid code is entered, the unit will respond with the current parameters programmed for that function; the VRC2000 will then allow you to edit/change them.

One important item to make the setup process easier is to time DTMF entries correctly. Experiment with the set-up procedures a few times to understand the way the VRC2000 responds to entries; practice initiating and completing a set-up event.

Use local mode the first time the VRC2000 is set up. The set-up process will be easier if you connect an amplifier and speaker is connected to the AUDIO OUT BNC connector on the VRC2000's rear panel. After, apply AC power to the unit.

Security

The VRC2000 provides three security levels: operator, user and system.

Operator

Operator access allows metering and status-channel readings to be taken. Commands cannot be issued to the VRC2000, and alarms cannot be cleared.

User

User access allows metering and status-channel readings to be taken, the VRC2000's command-channel switches can be activated, and alarms can be cleared.

VRC2000 Setup
Continued 

System

System access allows any metering, status or command channel to be set up, and any VRC2000 programming to be changed. System access also allows any access codes for any of the three security levels to be changed. Command-channel outputs cannot be triggered, readings from the metering and status channels cannot be taken, and alarms cannot be cleared.

Changing Access Codes

To change access codes for any security level, follow these step-by-step instructions:

Step 1

Press the LOCAL/REMOTE button [3] (See Figure 11, below.) on the VRC2000's front panel.

Figure 11. VRC2000 front-panel controls

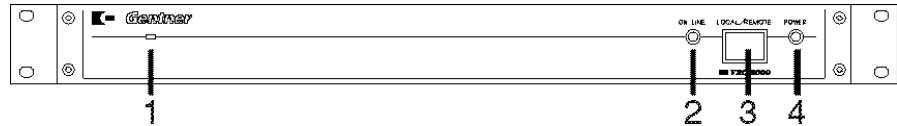

The unit will respond:

- SETUP ENABLED. PLEASE ENTER SYSTEM ACCESS CODE.

The VRC2000 will allow 10 seconds to completely enter the default system-access code (below) on the DTMF telephone pad:

☎ “1 2 3 4 5 6 7”

If the correct sequence of numbers were entered, the VRC2000 will respond:

- THANK YOU. PLEASE SELECT FUNCTION FOR PROGRAMMING.

If the unit does not respond, either

- 1) the connections between telephone and the VRC2000 are incorrect
- 2) the wrong sequence of numbers was entered
- 3) the sequence of numbers was not entered quickly enough
- 4) the telephone being used has poor DTMF tone quality

Check the connections and try again until the indicated response from the VRC2000 is received.

If invalid number sequences or symbols are entered, the VRC2000 will say

- ERROR.

This indicates an entry the VRC2000 cannot accept for the current parameter. If the ERROR message comes, begin the programming sequence for the parameter again.

DEFAULT PARAMETER NOTE:

Default parameters are enclosed in {braces}. Change parameters enclosed in {braces} when programming the VRC2000.

Step 2

In order to change the access codes for all three security levels, enter

☛ “0 9 0”

The VRC2000 will respond:

- OPERATOR ACCESS CODE IS {0, 1, 2, 3, 4} ... [BEEP]
- USER ACCESS CODE IS {1, 2, 3, 4, 5} ... [BEEP]
- SYSTEM ACCESS CODE IS {1, 2, 3, 4, 5, 6, 7} ... [BEEP]

The VRC2000 is reporting, in order of priority, the access codes for all three security levels. The pause between the end of an access code and the [BEEP] is *four seconds* long. New access codes should be entered *during* that four-second pause.

To change the access codes, enter

☛ “0 9 0”

The VRC2000 will respond as before. Immediately after, the VRC2000 says

- OPERATOR ACCESS CODE IS 0, 1, 2, 3, 4

Promptly enter the following sequence of numbers:

☛ “1 1 1 1 1”

After the last number in the above sequence is entered, the VRC2000 will respond with a double [BEEP]. The double [BEEP] indicates that a new operator access code has been entered.

ACCESS CODE NOTE:

When entering individual access codes (operator, user or system), any five digits can be used.

The VRC2000 will say

- USER ACCESS CODE IS 1, 2, 3, 4, 5

As soon as the VRC2000 completes this statement, enter the following sequence of numbers:

☛ “2 2 2 2 2”

The VRC2000 will double [BEEP] again, then say

- SYSTEM ACCESS CODE IS 1, 2, 3, 4, 5, 6, 7

Promptly enter the following sequence:

☛ “3 3 3 3 3 3 3”

The VRC2000 will double [BEEP] again to confirm that a new system access code had been entered.

VRC2000 Setup
Continued 

Step 3

Verify the newly entered access codes by entering

☛ “0 9 0”

The VRC2000 should respond:

- OPERATOR ACCESS CODE Is 1, 1, 1, 1, 1 ... [BEEP]
- USER ACCESS CODE Is 2, 2, 2, 2, 2 ... [BEEP]
- SYSTEM ACCESS CODE Is 3, 3, 3, 3, 3, 3, 3 ... [BEEP]

If the VRC2000 does not respond as indicated above, an error entering the new access codes may have been made. Go through the process (See [Step 2, previous page.](#)) again until the new access codes have been correctly entered.

Internal Battery/Access Code Check

Verify that the VRC2000’s internal lithium battery is properly connected, and that the new access codes have been properly entered and stored. Following these step-by-step instructions:

Step 1

Press the LOCAL/REMOTE button [3] (See [Figure 11a, below.](#)) on the VRC2000’s front panel to exit setup mode. The button light will extinguish, and the VRC2000 will say

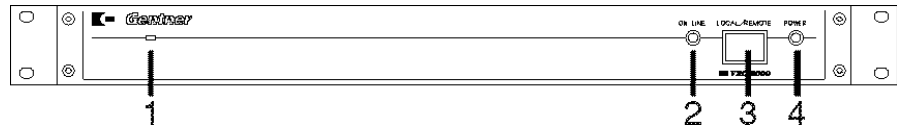

Figure 11a. VRC2000 front-panel controls

- SETUP DISABLED. GOOD-BYE.

Step 2

Unplug the VRC2000’s AC power cord, wait 25–30 seconds, and plug it back in. The VRC2000 should respond:

- DATA OK. CLOCK OK.

However, the VRC2000 may also say

- DATA ERASED. CLOCK ERASED.

If this occurs, the VRC2000’s internal-lithium battery is not properly enabled.

Step 3

Press the LOCAL/REMOTE button [3] on the VRC2000’s front panel. The button will light red and the VRC2000 will say

- SETUP ENABLED. PLEASE ENTER SYSTEM ACCESS CODE.

With the DTMF pad, enter the new system access code programmed in Changing Access Codes ([Page 12](#)).

☛ “3 3 3 3 3 3”

ACCESS CODE NOTE:

If a different access code was programmed from the one in the exercise, enter the access code programmed.

The VRC2000 should respond:

- THANK YOU. PLEASE SELECT FUNCTION FOR PROGRAMMING.

If the VRC2000 does not respond with this message, there was an error entering the new system access code, the unit was not properly programmed with the new system access code or the internal lithium battery was not placed correctly.

ACCESS ERROR NOTE:

If unable to obtain access to the VRC2000's programming functions with the new system access code, remove AC power from the VRC2000, remove all status and metering channel inputs from the unit, then remove the Berg jumpers on the internal lithium battery. Replace the battery jumper, reconnect all status and metering channel inputs, and return AC power to the VRC2000.

If not done so previously, program your own set of access codes for all three security levels. Write these access codes into the provided spreadsheet ([Appendix H: Setup Worksheets, Page 117](#)).

ACCESS CODE NOTE:

When determining access codes, use the letters on the DTMF pad to spell out meaningful words. This will make the codes easier to remember.

*Do not forget or lose your written record of the access codes. Do not program the access codes carelessly. If the access codes are lost or forgotten, the *only* way to gain access to the VRC2000 is to remove the jumper on the internal lithium battery and unplug the VRC2000. This will *erase all programmed functions* and *all parameters and functions* will have to be reprogrammed.*

Turning the VRC2000 Voice On/Off

Disabling the VRC2000's voice functions in setup mode will allow long strings of numbers with the DTMF pad without waiting for the voice to respond. Doing so will speed up programming. To disable the VRC2000's voice functions, follow these step-by-step instructions:

Step 1

Enter setup mode (either local or remote).

Step 2

Enter

☛ "9 3 0"

The VRC2000 will respond:

- VOICE OFF.

To reactivate the voice function, enter

☛ "9 4 0"

The VRC2000 will respond:

- VOICE ON.

The VRC2000 will accept very long strings of numbers when the voice function is disabled, although you can only enter one programming sequence at a time. If an invalid code number is entered with the voice function off, the VRC2000 will respond with an ERROR message.

VOICE FUNCTION NOTE:

The voice function will automatically be turned back on after a valid programming sequence is entered. You will hear an ERROR message after the voice function is turned off if you enter an invalid programming sequence; begin the programming sequence for the parameter again if an ERROR message is received.

Toggling Between User and Setup Modes

Toggling between the user and setup modes can be done at any time. When in local setup mode, toggle to the local user mode by entering

☛ “9 2 0”

The VRC2000 will respond:

- USER ENABLED.

Toggle back to local setup mode by entering the same “9 2 0” sequence.

When in the remote user mode, toggle to remote setup mode by entering

☛ “9 1 0”

The VRC2000 will say

- SETUP ENABLED. PLEASE ENTER SYSTEM ACCESS CODE.

Now enter the correct seven-digit system access code in order to proceed with any set-up function.

Toggle back to remote user mode by entering the same “9 1 0” sequence.

SETUP MODE NOTE:

The setup mode cannot be entered from the operator security level. Attempting to do so will result in an ERROR message.

Changing the System Identifier

The system identifier is the greeting the VRC2000 gives when a user signs on to the system; it can be customized, as long as it is composed of *exactly 20 words*.

The default system identifier states

- HELLO. THIS IS THE VRC2000 WITH VOICE, MODEM OR RADIO ACCESS. PLEASE ENTER ACCESS CODE.

This statement can be altered to include the station call letters or other words relevant to the facility.

To change the system identifier, first sign on to the VRC2000 in the setup mode and enter the system access code. Then enter

☛ “0 8 0”

The VRC2000 will respond with the same message stated on the previous page.

Now enter the following sequence of DTMF tones ([Table 1, below](#)):

Table 1. System Identifier Word List

<u>DTMF Code</u>	<u>Word Definition</u>
☛ “4 6 4”	• HELLO
☛ “7 2 6”	• THIS
☛ “4 9 7”	• IS
☛ “7 2 2”	• THE
☛ “1 0 0”	• A
☛ “1 0 1”	• B
☛ “1 0 2”	• C
☛ “1 0 3”	• D
☛ “7 3 9”	• TRANSMITTER
☛ “6 8 5”	• SITE
☛ “0 5 6”	• (5 MILLISECONDS SILENCE)
☛ “0 5 6”	• (5 MILLISECONDS SILENCE)
☛ “0 5 6”	• (5 MILLISECONDS SILENCE)
☛ “0 5 6”	• (5 MILLISECONDS SILENCE)
☛ “0 5 6”	• (5 MILLISECONDS SILENCE)
☛ “0 5 6”	• (5 MILLISECONDS SILENCE)
☛ “6 1 0”	• PLEASE
☛ “4 0 0”	• ENTER
☛ “2 0 4”	• ACCESS
☛ “3 1 0”	• CODE

The VRC2000’s system identifier is now programmed. Verify that the new system identifier was correctly programmed by entering the “0 8 0” sequence on the DTMF pad.

The VRC2000 can be programmed with almost any desired statement; the only limit is the VRC2000’s vocabulary of almost 800 words. Refer to the Appendix I: Word List ([See Page 125.](#)) for a complete listing of the VRC2000’s vocabulary.

Gentner Communications recommends that the system identifier always begin with the words

- HELLO. THIS IS THE

Also always use the words

- PLEASE ENTER ACCESS CODE

at the end of the system identifier. This will remind users that they have to enter an access code to operate a VRC2000.

SYSTEM IDENTIFIER NOTE:

For maximum security, programming the system identifier solely with silences may be desirable.

The use of silences in the system identifier will help make the VRC2000's statements more understandable.

Sixty DTMF tones, entered correctly, are required to program the VRC2000's system identifier. Once the first DTMF tone in the programming sequence is entered, the VRC2000 will wait until all 60 tones are entered.

If not completed previously, now program the VRC2000 with your own system identifier. First, decide what the unit will say ([Appendix I: Word List, Page 125](#)). Make notes on the tones to be programmed into the VRC2000. Remember to include *exactly 20 words (60 DTMF tones)* in the system identifier.

VOICE OFF NOTE:

Using the VOICE OFF command "9 3 0" when programming the system identifier will save time. Although it is not mandatory, always remember to turn the voice function back on with the VOICE ON command "9 4 0" when finished.

Setting the Clock

The VRC2000 has a real-time clock and calendar used to tag alarms. Setting this clock accurately is important. The VRC2000's clock can also be set up to automatically change to and from daylight savings time.

To set the VRC2000 clock, enter setup mode with the system access code. Next, enter

☛ "0 6 0"

The VRC2000 will respond:

- TIME OF DAY HOURS ARE ... {TWELVE} ... [BEEP]
- TIME OF DAY MINUTES ARE ... {ZERO} ... [BEEP]
- TIME OF DAY SECONDS ARE ... {ZERO} ... [BEEP]
- TIME OF DAY IS ... {AM} ... [BEEP]
- DAYLIGHT SAVINGS TIME IS ... {DISABLED} ... [BEEP]
- DAY OF WEEK IS ... {WEDNESDAY} ... [BEEP]
- DATE IS ... {DECEMBER SIXTEEN, NINETEEN EIGHTY-EIGHT} ... [BEEP]

In the pauses before each [BEEP], enter new numbers that will reset each portion of the clock/calendar.

TIME/CLOCK NOTE:

The time actually spoken by the VRC2000 may vary from the information stated above, depending on the length of time which has elapsed since power was applied to the unit. However, the format will be the same as indicated above.

The clock is not updated until the last number is entered for each individual time/date function. This means the time can be set to accurate time bases (i.e. studio clock or WWV).

When the daylight savings time function is enabled, the VRC2000 will automatically advance its clock forward one hour at 2 a.m. on the first Sunday in April. It will also move the clock back one hour at 2 a.m. on the last Sunday in October.

DAYLIGHT SAVINGS TIME NOTE:

The daylight savings time function adjusts the clock only. No programmed time-of-day operations are affected.

Clock Setting Exercise

In the following example, you will set the clock to 4:30 p.m., Saturday, May 28, 1988, with the daylight savings time function enabled.

Enter

☛ “0 6 0”

The VRC2000 will respond by beginning the clock/calendar setting sequence. After each statement listed below, enter the corresponding command in Table 2 (below) or your current information:

Table 2. Clock/Calendar Setting Exercise

<u>VRC2000 Says</u>	<u>You Enter</u>	<u>VRC2000 Responds</u>
• TIME OF DAY HOURS ARE ...	☛ “0 4”	• [BEEP] [BEEP]
• TIME OF DAY MINUTES ARE ...	☛ “3 0”	• [BEEP] [BEEP]
• TIME OF DAY SECONDS ARE ...	☛ “0 0”	• [BEEP] [BEEP]
• TIME OF DAY IS ...	☛ “#”	• [BEEP] [BEEP]
• DAYLIGHT SAVINGS TIME IS ...	☛ “#”	• [BEEP] [BEEP]
• DAY OF WEEK IS ...	☛ “7”	• [BEEP] [BEEP]
• DATE IS ...	☛ “0 5 2 8 1 9 8 8”	• [BEEP] [BEEP]

VRC2000 REPORT NOTE:

The VRC2000 will always report the time and date information already stored in the unit. Be sure to enter new information after the VRC2000 states the stored information, and before the [BEEP].

The double [BEEP] indicates that you have successfully entered new information.

The date must always be entered in month/day/year format, with *all* digits for the year included.

Use two digits to make the hour, minutes, seconds, month, and day entries.

Setting a.m./p.m.

Use the “#” symbol to set the clock for p.m. Enter a “*” for a.m.

Daylight Savings Function

Enter a “#” to enable the daylight savings time function. Use the “*” symbol to disable the daylight savings time function.

Verify the clock settings by entering the “0 6 0” sequence again.

Now (if not done already) set the clock according to your local time and the

current date. Refer to Appendix I: Word List (See Page 125.) for the command numbers for each part of the clock/calendar functions. Write out the planned numbers to be entered before beginning. Use the worksheets in Appendix H: Setup Worksheets (See Page 117.) to plan and record programming to be entered into the VRC2000.

Telephone Interface

Several options make the VRC2000 work correctly with particular telephone systems: pulse/tone selection, ring count, inactivity timer and precision dial-tone waiting.

Pulse/Tone Selection

This option allows selection of DTMF or pulse dialing for VRC2000 outbound calling.

Ring Count

This option allows the VRC2000 to be programmed to answer incoming calls after a certain number of rings. For example, if the ring count is set to 0, the unit is constantly online, allowing use of the VRC2000 with a dedicated four-wire connection. (Such a dedicated four-wire connection will provide 24-hour access to the site.) Unless using such a dedicated four-wire system, program the unit to answer on the first or second ring.

Inactivity Timer

This option allows an inactivity timer to be switched ON or OFF. When the inactivity timer is ON, the VRC2000 must receive at least one valid DTMF command every five minutes, or it will automatically exit the setup, user and/or operator modes. If the inactivity timer is OFF, the unit will exit the setup, user and/or operator mode after one hour if it has not received any valid DTMF commands; it will exit the user mode only when the you properly sign off or hang up the telephone line.

Unless using the VRC2000 on a dedicated telephone line (for constant access to commands), Gentner Communications recommends leaving the inactivity timer ON.

Dial-Tone Wait

This allows the VRC2000 to be programmed to wait for a precision dial tone before beginning to dial an outbound number. Some older telephone systems, or some systems with poor quality lines, do not have reliable precision dial tone. In such cases, the VRC2000 can be programmed to wait six seconds before beginning to dial an outbound number.

Unless you are in an area with a very old telephone system, or an area with very poor quality lines, Gentner Communications recommends programming the VRC2000 to wait for a precision dial tone before dialing.

Telephone Interface Setting Exercise

In the following exercise, program the VRC2000 to make outbound calls with pulse dialing, answer automatically after two rings, enable the inactivity timer and enable dial-tone wait function.

First, enter

☛ “0 7 0”

The VRC2000 will respond by beginning the telephone interface option sequence. After each statement listed in Table 3 (See below.), enter the command listed:

Table 3. Telephone Interface Setting Exercise

<u>VRC2000 Says</u>	<u>You Enter</u>	<u>VRC2000 Responds</u>
• DIALING IS {DTMF} ...	☛ “*”	• [BEEP] [BEEP]
• NUMBER OF RINGS BEFORE ANSWERING IS {TWO} ...	☛ “2”	• [BEEP] [BEEP]
• INACTIVE TIME DISCONNECT IS {ENABLED} ...	☛ “#”	• [BEEP] [BEEP]
• DIAL TONE WAIT IS {ENABLED} ...	☛ “#”	• [BEEP] [BEEP]

VRC2000 REPORT NOTE:

The VRC2000 will report the information already stored in the unit. Be sure to enter new information after the VRC2000 states the stored information, and before you hear a [BEEP].

The double [BEEP] indicates successfully entered new information.

This series of DTMF entries has programmed the VRC2000 to use pulse dialing for all outbound dialing and answer after two rings. The inactivity timer has also been switched ON, and the dial-tone wait function has been enabled.

Pulse/DTMF Dialing

When programming the VRC2000, enter a “#” symbol to enable DTMF outbound dialing; use “*” for outbound pulse dialing.

Inactive Disconnect Function

Enter a “#” symbol to enable the inactive time disconnect function. Use the “*” to disable the inactive time disconnect function.

Dial-Tone Wait Function

Enter a “#” to enable the dial-tone wait function. Use “*” to disable the dial tone wait function.

This set of commands should allow the VRC2000 to function properly in most circumstances. To change any of the parameters of the telephone interface options, refer to Appendix I: Word List (See Page 125.) for a complete listing of optional command codes.

After programming the telephone interface options, record the setup on the worksheet provided for this purpose in Appendix H: Setup Worksheets (Page 117).

Setting Up Outbound Telephone Numbers

The VRC2000 can be programmed to automatically dial certain telephone numbers and report alarm conditions; thus, all parameters of the equipment connected to the VRC2000 no longer need to be constantly monitored. Critical parameters can be set to trigger an alarm if certain conditions are met. When this happens, the VRC2000 will then automatically call the programmed outbound telephone numbers and report the alarm.

The VRC2000 can be programmed to dial up to five different telephone numbers. The unit can be set up to call only certain numbers for certain alarm conditions, or call each of the numbers in sequence.

Data Interface Option

If the VRC2000 is installed with a Data Interface ([See Appendix C: Accessories, Page 100.](#)), the VRC2000 can be programmed to automatically activate the Data Interface and report alarms in an electronic data format with a dedicated PC and modem at the studio site.

For each outbound telephone number, select whether it will report alarms using voice or the Data Interface's modem selection. Each outbound telephone number can also be programmed to either use a telephone line to transmit this information, or to use a two-way radio set.

If using the Setup VRC2000 software or VRC-Win software to perform auto-logging functions, the VRC2000 will use the first outbound telephone number programmed for modem access to transmit auto-logging data.

See the Data Interface Installation and Operations Manual for information about how to install and use the Data Interface. Refer to the Setup VRC2000 Installation and Operations Manual for instructions on how to use it to program the VRC2000's outbound telephone numbers and auto-logging functions. See the VRC-Win Installation and Operations Manual for full description of its operational parameters.

Outbound Telephone Numbers

There are four output configurations available for each of the five outbound telephone numbers: telephone modem, telephone voice, radio modem and radio voice.

Telephone Modem. This output configuration causes the VRC2000 to dial the selected outbound telephone number, turn on the Data Interface and transmit pending alarm information in an electronic data format.

TELEPHONE MODEM NOTE:

The VRC2000 must be equipped with the Data Interface in order to use the telephone modem output configuration.

Telephone Voice. This output configuration allows the VRC2000 to dial the selected outbound telephone number and use its electronic voice to transmit information about the pending alarm.

Radio Modem. This output configuration causes the VRC2000 to activate the push-to-talk output on the VRC2000, turn on the Data Interface, and transmit information about the pending alarm in an electronic data format.

RADIO MODEM NOTE:

The VRC2000 must be equipped with the Data Interface in order to use the radio modem output configuration.

Radio Voice. This output configuration causes the VRC2000 to activate the push-to-talk output on the VRC2000, and use its electronic voice to transmit information about a pending alarm.

Message Only Function

In *either* the phone voice or radio voice output configuration, the message-only function for the outbound telephone number can be enabled. The message-only function will allow the VRC2000 to call a number and *only* leave a message to return the call. With the message-only function enabled, the VRC2000 will wait until a call is answered (or until the 20-second timeout period), state the programmed system identifier, and say

- PLEASE RETURN CALL.

This allows the VRC2000 to call you directly and request a call back, or the VRC2000 can call and leave this message on your answering machine. In either case, the VRC2000 will *only leave a message*; you *cannot gain access to the system* without returning the call and properly entering the appropriate access code. The message-only function is ideal for engineers who depend on a telephone pager for alarm notifications.

If the message-only function is disabled, the call does not need to be returned; the VRC2000 will call the outbound telephone number and immediately allow an access code to be entered and commands to be issued.

Outbound Call Sequence

When an alarm condition is present, the VRC2000 will keep dialing outbound telephone numbers until corrective action is taken. The VRC2000 will dial each of the enabled outbound telephone numbers stored in memory until the alarm(s) is cleared.

The unit will pause for one minute between each outbound call in the sequence, allowing time to make an incoming call to the VRC2000. The unit will also pause for 10 minutes after the last call in the sequence before beginning the sequence over again.

OUTBOUND CALL SEQUENCE NOTE:

If an alarm is programmed to call one specific number, and that alarm is the oldest alarm that has been recognized by the VRC2000, the unit will call that one specific number once every minute until that alarm has been cleared. It will not pause for 10 minutes at any time.

Number Disabling

Each of the programmed outbound telephone numbers can be enabled/disabled. This allows all five numbers to be programmed but, if someone goes on vacation, that particular outbound telephone number can be disabled until that person returns.

However, be cautious when disabling outbound telephone numbers. If the VRC2000 is programmed to dial a particular number when an alarm condition is present, if the number is disabled, verify that the VRC2000 can always call at least one enabled outbound telephone number on each alarm set up.

Auto-Logging and Alarm Logging

To use the VRC2000 for auto-logging and alarm logging functions, at least one outbound telephone number should be programmed for phone modem or radio modem output. Gentner Communications recommends that outbound telephone number 1 be set for modem output. This will ensure that alarms are logged before they are cleared.

Telephone Number Programming Exercise

The VRC2000 was delivered with no programmed outbound telephone numbers. To become familiar with the process, perform the following exercise.

First, enter

☛ “1 0 1 #”

This accesses the VRC2000’s first telephone number. Now enter a new telephone number into this first position.

The VRC2000 will respond:

- PHONE NUMBER ONE IS ... [BEEP]
- OUTPUT CONFIGURATION FOR PHONE NUMBER ONE IS ... {PHONE VOICE} ... [BEEP]
- MESSAGE ONLY FOR PHONE NUMBER ONE IS ... {DISABLED} ... [BEEP]

During each pause, a new outbound telephone number for this position can be entered. Choose which output configuration to use for this number, and enable/disable the message-only function for this phone number.

In the following example, you will program telephone number one with the number 555-1212, select the radio voice output configuration, and enable the message-only function.

First, enter

☛ “1 0 1 #”

Then refer to [Table 4 \(below\)](#).

Table 4. Telephone Number Programming Exercise

<u>VRC2000 Says</u>	<u>You Enter</u>	<u>VRC2000 Responds</u>
• PHONE NUMBER ONE IS ...	☛ “5 5 5 1 2 1 2 #”	• [BEEP] [BEEP]
• OUTPUT CONFIGURATION FOR PHONE NUMBER ONE IS ...	☛ “7”	• [BEEP] [BEEP]
• MESSAGE ONLY FOR PHONE NUMBER ONE	☛ “#”	• [BEEP] [BEEP]

VRC2000 REPORT NOTE:

The VRC2000 will report the information already stored in the unit. Be sure to enter new information after the VRC2000 states the stored information, and before you hear a [BEEP].

The double [BEEP] signal indicates successfully entered new information.

Enter a “#” at the end of each telephone number. This tells the VRC2000 that you have entered a complete number. The “*” indicates a *two-second pause* in the outbound telephone number. All outbound telephone numbers should consist of 30 digits or less.

Telephone Voice Output Configuration. Enter a “*” to select the phone voice output configuration.

- Enable Message Only. Enter a “#” to enable the message-only function

for an outbound telephone number.

- Disable Message Only. Enter a “*” to disable the message-only function for an outbound telephone number.

Telephone Modem Output Configuration. Enter a “#” to select the phone modem output configuration.

Radio Voice Output Configuration. Enter a “7” to select the radio voice output configuration.

- Enable Message Only. Enter a “#” to enable the message-only function for an outbound telephone number.

- Disable Message Only. Enter a “*” to disable the message-only function for an outbound telephone number.

Radio Modem Output Configuration. Enter a “9” to select the radio modem output configuration.

VRC2000 Configurations

- ▲ Telephone Voice Output (*)
- ▲ Telephone Modem Output (#)
- ▲ Radio Voice Output (7)
- ▲ Radio Modem Output (9)

Figure 12. Telephone configuration quick reference

See Figure 12 (left) for telephone configuration quick reference.

RADIO/PHONE MODEM NOTE:

The VRC2000 must be equipped with the Data Interface to use radio modem or phone modem output configuration. Also, if the outbound telephone number is programmed to use either the phone modem or radio modem output configuration, the VRC2000 will not ask you to enable (“#”) or disable (“”) the message-only function.*

To verify that the new telephone number was properly programmed, enter

☛ “1 0 1”

The VRC2000 should respond:

- PHONE NUMBER ONE IS ... 5 5 5 1 2 1 2 ... [BEEP]
- OUTPUT CONFIGURATION FOR PHONE NUMBER ONE IS ... RADIO VOICE ... [BEEP]
- MESSAGE ONLY FOR PHONE NUMBER ONE IS ... ENABLED ... [BEEP]

Now try disabling phone number 1. First, enter

☛ “1 0 1 *”

The VRC2000 will respond:

- PHONE NUMBER ONE IS DISABLED.

To enable phone number 1, enter

☛ “1 0 1 #”

The VRC2000 will respond with the number entered into this position and message-only mode status.

Notice that pressing “#” at the end of the “1 0 1” entry enables that outbound telephone number and allows the parameters of that outbound telephone

VRC2000 Setup
Continued 

number to be programmed. Pressing “*” after the entry disables that telephone number. This applies to all five outbound telephone numbers.

Pager Number Programming Example

Often, it is desirable for the VRC2000 to call a pager to report alarms. When programming the VRC2000 to call a pager, the “*” (two-second pause) is critical. See Table 5 (below).

Table 5. Pager Number Programming Exercise

<u>VRC2000 Says</u>	<u>You Enter</u>	<u>VRC2000 Responds</u>
• PHONE NUMBER ONE IS ...	☛ “5 5 5 1 2 1 2 * * * * #”	• [BEEP] [BEEP]
• OUTPUT CONFIGURATION FOR PHONE NUMBER ONE IS ...	☛ “*”	• [BEEP] [BEEP]
• MESSAGE ONLY FOR PHONE NUMBER ONE	☛ “#”	• [BEEP] [BEEP]

PAGER PAUSE NOTE:

Different pagers will require differing lengths of pauses before entering the call-back phone number. Consult your pager user documentation to determine the length of the pause.

Now enter five of your own telephone numbers into the VRC2000. Each phone number position on the unit does not have to be filled, and the same number can be entered in more than one position.

Refer to Appendix H: Setup Worksheets (See Page 117.) for a worksheet designed for recording the numbers entered into each VRC2000 phone number position.

The five outbound telephone number positions are accessed by entering the following codes (Table 6, below):

Table 6. Outbound Telephone Number Command Codes

<u>Command Code</u>	<u>Outbound Telephone Number</u>
☛ “1 0 1 #”	Phone Number 1
☛ “1 0 2 #”	Phone Number 2
☛ “1 0 3 #”	Phone Number 3
☛ “1 0 4 #”	Phone Number 4
☛ “1 0 5 #”	Phone Number 5

Remember to enter a “#” at the end of each of the numbers entered. This tells the VRC2000 that a complete telephone number had been entered.

OUTBOUND TELEPHONE NUMBER NOTE:

Two-second pauses can be programmed into any phone number by entering a “”. This pause can be useful for dialing over some long-distance services (i.e. MCI or Sprint) that require special access codes to be entered. Remember, all outbound telephone numbers must consist of 30 digits or less, including pause symbols.*

Alarms

The VRC2000 uses alarms to trigger certain actions. Both the alarm and the action to be taken when the alarm is triggered are user-programmable. It is important to understand the concept of alarms, and how the VRC2000 can be programmed to take action based on alarms.

Alarm Storage

The most recent 32 alarms are stored by the VRC2000 until they are cleared. If more than 32 alarms are activated, *only* the most recent 32 alarms are saved in the unit.

Reporting Alarms

The VRC2000 can be programmed to call when an alarm is activated and report the alarm condition; *or* the unit can also be programmed to automatically issue a command to change the site equipment's operating parameter(s) when an alarm is activated. The VRC2000 can also be programmed to perform both tasks, or to take no action at all.

Status Channels

The VRC2000 has 16 status channels; the VRC2000 can be programmed to activate an alarm when any one of the status channels changes its state. For more information, see Setting Up Status Channels (below).

Metering Channels

The VRC2000 has 16 metering channels. For each metering channel, alarms can be programmed for any of the four tolerance limits (two limits above nominal operating condition, two limits below nominal operating condition). For more information, see Metering Channels ([Page 36](#)).

Programming VRC2000 Alarm Delays and Channels

When programming the VRC2000, there are several constants, be it programming an alarm delay, a status channel, command channel or metering channel. One of utmost importance is that you use *two digits* when referring to channels (command, metering or status).

Alarm Delay Examples

"0 9" would program this status channel's alarm delay for nine seconds

"5 6" would sets this metering channel's alarm delay for 56 seconds

Channel Examples

"0 6" will associate command channel 6 with a status channel

"0 3" will assign command channel 3 to a status-channel parameter

"1 4" would program command channel 14 as the default command channel for the selected metering channel

"1 1" would program command channel 11 as the automatic command channel for the metering channel's second low tolerance limit

Setting Up Status Channels

The VRC2000 has 16 status channels, each of which can either be high (open state) or low (closed state). The VRC2000 can be programmed to provide specified information when a status channel is queried. Any status channel can be set to set off an alarm ([see Alarms, previous page](#)).

Status channels allow monitoring of site parameters that have only *two* states, such as checking if the exterior building lights are on or off. If the lights are supposed to be on, but they are malfunctioning, the VRC2000 can

be programmed to cause an alarm condition. The VRC2000 can also be programmed to turn on a set of auxiliary lights if the main set failed.

CHANNEL OVERLOAD NOTE:

Be very careful not to overload status channels with excessive voltage or current. Overloads can seriously damage the VRC2000. For status-channel electrical specifications, see Specifications (Page 90).

Alarm Delay

There is an alarm delay built into each status channel. The amount of time that will pass between when a status channel changes states (from high to low, or vice versa) and when an alarm condition is activated is user-programmable. The alarm delay can be anywhere from one to 99 seconds. *Always use two digits when programming this parameter.*

Preparation for Programming

Because each status channel has many functions and options, setting up status channels will take some time. To speed up the process, it is important to plot out the site parameters to be monitored with the status channels before beginning to program the VRC2000. When doing this, be sure to decide if the parameter being monitored should cause an alarm, and if the VRC2000 should automatically take some action when the a status-channel state changes.

Status Channel Programming

The VRC2000 can access set-up information about a particular status channel. When this is done, the unit will list functions available for the status channel.

For each parameter of the 10 status-channel parameters, the VRC2000 will respond with a preprogrammed message, followed by the default parameter, followed by a [BEEP].

To begin, enter

☛ “7 0 1”

The VRC2000 will respond with the following 10 phrases:

- CHANNEL IDENTIFIER FOR STATUS CHANNEL ONE IS ... {5 MILLISECONDS SILENCE, 5 MILLISECONDS SILENCE} ... [BEEP]

STATUS CHANNEL IDENTIFIER NOTE:

Two words from the VRC2000 word list (See Appendix I: Word List, Page 125.) for the unit to use as a status-channel identifier. The default setting for each status channel is two five-millisecond silences. Silences do count as words.

- DEFAULT COMMAND CHANNEL FOR STATUS CHANNEL ONE IS ... {DISABLED} ... [BEEP]

STATUS-COMMAND CHANNEL ASSOCIATION NOTE:

A status channel can be associated with a command channel. This will allow control of the selected command channel directly after requesting information about a status channel. The default setting {Disabled} indicates that this status channel is not associated with any command channel.

For example, a command channel that controls the ON/OFF conditions of a blower can be associated with a status channel that indicates the ON/OFF condition of the same blower. When the status channel is accessed to determine the blower's status, the associated command channel can be immediately accessed to turn the blower ON or OFF without having to enter the access code for that command channel.

To disable a default command channel assignment for a status channel, program the unit with the digits "0 0" when setting up this parameter. The "0 0" command-channel assignment tells the VRC2000 that no status channel will be associated with this command channel.

- ALARM DELAY FOR STATUS CHANNEL ONE IS ... {ONE} ... [BEEP]

The delay between the time an alarm is generated and the time automatic commands are issued can be programmed for anywhere from *one to 99 seconds*. Alarm delays are handy in smoothing transients and time-based automatic functions. Once the alarm delay time passes, the VRC2000 will issue automatic commands until the status channel's condition changes. Thus, an alarm is not actually issued if the condition that triggered the alarm is cleared up before the alarm delay time has passed. *Always use two digits to enter this parameter.*

- LOW INPUT IDENTIFIER FOR STATUS CHANNEL ONE IS ... {INPUT CLOSED} ... [BEEP]

Any two words from Appendix I: Word List ([See Page 125.](#)) can be programmed as an identifier, such as [ON AIR] [HIGH CHARGE] [SYSTEM OK].

- ALARM ON LOW INPUT OF STATUS CHANNEL ONE IS ... {DISABLED} ... [BEEP]

The low state of any status channel can either be enabled or disabled. The default setting for the low state of any status channel is *disabled*. When programming the VRC2000, enter "#" to enable the alarm for this parameter; a "*" will disable the alarm for this parameter.

- COMMAND CHANNEL NUMBER FOR LOW INPUT OF STATUS CHANNEL ONE IS ... {DISABLED} ... [BEEP]

Any command channel can be programmed to be automatically activated by a low state on a status channel. This is called an automatic command. The default setting, {Disabled}, indicates that there is no command channel tied to the status channel's low state.

To disable an automatic command-channel assignment, program the VRC2000 with the digits "0 0" when setting up this parameter. The "0 0" command-channel assignment tells the VRC2000 that automatic commands should not be sent when this status-channel's input goes low. *Always use two digits when programming this parameter.*

Each command channel has two switches. If the VRC2000 is programmed to activate a command channel when a status channel is low, the VRC2000 will ask you to select the switch to be activated for that command channel. Enter "#" to automatically activate the B switch; enter "*" to automatically activate the A switch.

VRC2000 Setup
Continued 

- HIGH INPUT IDENTIFIER FOR STATUS CHANNEL ONE IS {INPUT OPEN} ... [BEEP]

Any two words from Appendix I: Word List ([See Page 125.](#)) can be programmed to replace {Input Open}.

- ALARM ON HIGH INPUT OF STATUS CHANNEL ONE IS {DISABLED} ... [BEEP]

An alarm for the high state of any status channel can either be enabled or disabled. That is, with the alarm enabled, the VRC2000 will generate an alarm if the status channel goes *high*. When programming the VRC2000, enter “#” to enable the alarm for this parameter; enter “*” to disable the alarm for this parameter.

- COMMAND CHANNEL NUMBER FOR HIGH INPUT OF STATUS CHANNEL ONE IS ... {DISABLED} ... [BEEP]

Any command channel can be programmed to be automatically activated by a high state on a status channel. The default setting, {Disabled}, indicates that there is no command channel tied to the status channel's high state. To disable an automatic command-channel assignment, program the unit with the digits “0 0” when setting up this parameter. The “0 0” command-channel assignment tells the VRC2000 not to automatically activate any commands when this status channel's input goes high.

Each command channel has two switches. If the VRC2000 is programmed to activate a command channel when a status channel is high, the VRC2000 will also ask you to select the switch to be activated for that command channel. Enter a “#” to automatically activate the B switch; enter “*” to automatically activate the A switch.

- PHONE NUMBER FOR STATUS ALARM ONE IS ... {DIAL ALL} ... [BEEP]

Program the VRC2000 to dial any or all of the telephone numbers entered into the unit's memory when the VRC2000 senses an alarm on status channel 1. The default setting, {Dial All}, indicates that the VRC2000 will dial, in sequence, all numbers entered into the unit's memory when it senses an alarm on this status channel. The VRC2000 can also be programmed to dial only one number in memory.

To set up the VRC2000 to dial all telephone numbers in sequence, program this parameter with a “0”. To set up the VRC2000 to dial outbound telephone number 1 *only*, program the parameter with a “1”. To set up the unit to dial outbound telephone number 2 *only*, program this parameter with a “2”, and so on.

There are 16 status channels on your VRC2000. Each can be programmed with all the parameters listed above. Status channels are accessed with the following codes ([Table 7, next page, top](#)):

Table 7. Status Channel Access Codes

<u>You Enter:</u>	<u>To Access Status Channel:</u>
☎ "7 0 1"	1
☎ "7 0 2"	2
☎ "7 0 3"	3
☎ "7 0 4"	4
☎ "7 0 5"	5
☎ "7 0 6"	6
☎ "7 0 7"	7
☎ "7 0 8"	8
☎ "7 0 9"	9
☎ "7 1 0"	10
☎ "7 1 1"	11
☎ "7 1 2"	12
☎ "7 1 3"	13
☎ "7 1 4"	14
☎ "7 1 5"	15
☎ "7 1 6"	16

STATUS CHANNEL NOTE:

Notice that the "7" on your DTMF pad corresponds with the letter S. This is intended to help you remember that a code starting with a "7" will program status channels.

To program status channels, first enter the appropriate code for the channel you would like to program. Immediately after, the VRC2000 states its message, the desired set-up information. *All codes must be entered before the [BEEP].*

SINGLE BEEP NOTE:

The VRC2000 will emit a single [BEEP] after a set-up parameter if you do not make a new entry. If you do make a new entry after a set-up parameter is stated by the VRC2000, the unit will [BEEP] twice.

This process will proceed more quickly if the exact codes to be programmed are well planned. For this purpose, this manual includes worksheets in Appendix H: Setup Worksheets (Page 117).

Status Channel Programming Exercise

The following exercise will illustrate more fully how to program status channels.

Enter

☎ "7 0 1"

The VRC2000 will respond:

- CHANNEL IDENTIFIER FOR STATUS CHANNEL ONE IS ... {5 MILLISECONDS SILENCE, 5 MILLISECONDS SILENCE}

VRC2000 Setup
Continued 

Enter

☛ “7 3 2 5 1 3”

The VRC2000 responds with a double [BEEP].

The VRC2000 has now been programmed to state [TOWER LIGHTS] when information is requested about status channel 1. Or, if desired, any other two words from the VRC2000’s word list can be programmed ([Appendix I: Word List, Page 125](#)).

The VRC2000 will say

- DEFAULT COMMAND CHANNEL FOR STATUS CHANNEL ONE IS ... {DISABLED}

You enter

☛ “0 7”

The VRC2000 responds with a double [BEEP].

The unit has now been programmed to allow direct access to command channel 7 when status channel 1 is queried.

When the VRC2000 has been accessed with the user access code, enter “*” to activate the A switch of command channel 7 when reading status channel 1. Enter “#” to activate command channel 7’s B switch when reading status channel 1.

To disable the default command channel for this status channel, program the unit with the digits “0 0” when you setting up this parameter. The “0 0” command channel assignment tells the VRC2000 that no command channels will be associated with this status channel.

This function makes it easier and quicker to control selected parameters of remote equipment immediately after taking a reading for those parameters.

The VRC2000 will say

- ALARM DELAY FOR STATUS CHANNEL ONE IS ...{ONE}

You enter

☛ “2 5”

The VRC2000 will respond with a double [BEEP].

The alarm delay for status channel 1 is now set at 25 seconds. The unit will wait for 25 seconds after an alarm is generated before taking any action. If the condition which caused the alarm is cleared before the alarm delay time has expired, the VRC2000 will automatically clear the alarm and take no action.

The VRC2000 will state

- LOW INPUT IDENTIFIER FOR STATUS CHANNEL ONE IS {INPUT CLOSED}

You enter

☛ “5 1 3 5 7 0”

The VRC2000 will respond with a double [BEEP].

The VRC2000 is now programmed to say [LIGHTS OFF] when information is requested about status channel 1, and status channel 1 is closed.

The VRC2000 will say

- ALARM ON LOW INPUT OF STATUS CHANNEL ONE IS ... {DISABLED}

You enter

☛ “#”

The VRC2000 will respond with a double [BEEP].

The alarm for status channel 1’s low input has not been enabled. The VRC2000 will activate an alarm condition when the state of status channel 1 switches closed.

ENABLING ALARMS NOTE:

When programming the VRC2000, enter a “#” symbol to enable the alarm for any parameter. Enter a “” to disable the parameter’s alarm.*

The VRC2000 will say

- COMMAND CHANNEL NUMBER FOR LOW INPUT OF STATUS CHANNEL ONE IS ... {DISABLED}

You enter

☛ “0 3”

The VRC2000 will respond with a double [BEEP].

Command channel 3 has now been tied to status channel 1’s low state. This means that the VRC2000 will automatically activate a command channel 3 switch when status channel 1 goes low. The unit will wait for the alarm delay period to pass before it activates command channel 3.

The command channel can now be programmed to be automatically activate with a low state on a status channel. The default setting of {Disabled} indicates that there is no command channel tied to the low state of this status channel.

To disable an automatic command channel assignment, program the unit with the digits “0 0” when setting up this parameter. The “0 0” command-channel assignment tells the VRC2000 that you do not wish to automatically activate any commands when the input of this status channel goes low.

When tying a command channel to a status channel (as in this example), the VRC2000 will respond:

- ACTIVE COMMAND CHANNEL SWITCH FOR LOW INPUT OF STATUS CHANNEL ONE

VRC2000 Setup
Continued 

Is ...{A}

Now enter a code that will tell the VRC2000 *which switch* on command channel 3 to automatically activate when status channel 1 goes *low*.

You enter

☛ “#”

The VRC2000 will respond with the double [BEEP].

The VRC2000 is now programmed to automatically fire command channel 3’s B switch when status channel 1 goes low.

Enter “#” to program switch B for the selected command channel; enter “*” to program switch A of the selected command channel.

The VRC2000 will say

• HIGH INPUT IDENTIFIER FOR STATUS CHANNEL ONE IS ... {INPUT OPEN}

You enter

☛ “5 1 3 5 7 5”

The VRC2000 will respond with a double [BEEP].

The unit will now answer [LIGHTS ON] when information about status channel 1 is requested, and it is in the open state.

The VRC2000 will say

• ALARM ON HIGH INPUT OF STATUS CHANNEL ONE IS ... {DISABLED}

You enter

☛ “*”

The VRC2000 will respond with a double [BEEP].

The alarm for status channel 1’s high input is now disabled. The VRC2000 will *not* activate an alarm condition when the state of status channel 1 switches open.

When programming the VRC2000, enter a “#” symbol to enable the alarm for this parameter. Enter “*” to disable the alarm.

The VRC2000 will say

• COMMAND CHANNEL NUMBER FOR HIGH INPUT OF STATUS CHANNEL ONE IS ... {DISABLED}

You enter

☛ “0 4”

The VRC2000 will respond with a double [BEEP].

Command channel 4 has now been tied to the high state of status channel 1. This means that the VRC2000 will automatically activate a command channel 4 switch when status channel 1 goes high. The unit will wait for the alarm delay period to pass before it activates command channel 4.

Any command channel can be programmed to automatically activate with a high state on a status channel. The default setting, {Disabled}, indicates that there is no command channel tied to this status channel's high state.

To disable an automatic command-channel assignment, program the unit with the digits "0 0" when setting up this parameter. The "0 0" command-channel assignment tells the VRC2000 that no commands will be automatically activated when the input of this status channel switches high.

When tying a command channel to a status channel (as in this example), the VRC2000 will continue with the following:

- ACTIVE COMMAND CHANNEL SWITCH FOR HIGH INPUT OF STATUS CHANNEL ONE IS ... {B}

Now enter a code that will tell the VRC2000 *which switch* on command channel 4 to automatically activate when status channel 1 goes high.

You enter

☛ "#"

The VRC2000 will respond with a double [BEEP].

The VRC2000 has now been programmed to automatically fire command channel 4's B switch when status channel 1 goes high.

Enter "#" to program switch B for the selected command channel; enter "*" to program switch A of the selected command channel.

The VRC2000 will say

- PHONE NUMBER FOR STATUS ALARM ONE IS ... {DIAL ALL}

You enter

☛ "3"

The VRC2000 will respond with a double [BEEP].

The VRC2000 will now dial only outbound telephone number 3 when an alarm condition is generated by status channel 1. When an alarm is generated, the unit will wait for the programmed alarm-delay period, then dial the number entered in position three of the outbound telephone number memory.

OUTBOUND TELEPHONE NUMBER NOTE:

The VRC2000 does not check to see whether outbound telephone number 3 is enabled/disabled during this part of the programming procedure. See Setting Up Outbound Telephone Numbers (Page 21) for details.

VRC2000 Setup

Continued

Remember that the VRC2000 can store up to 32 alarms in memory. The oldest alarm in the system's memory determines which outbound telephone numbers will be dialed.

Enter a "0" to program the VRC2000 to dial all five numbers entered in the outbound telephone number memory when it senses an alarm condition on a status channel. The default setting is {Dial All}. If the programmed outbound telephone number is disabled, the VRC2000 will automatically reset this status channel to {Dial All} when an alarm is generated.

When you are ready to begin the final status-channel setup, use the worksheets in Appendix H (Page 117) to plan the exact codes to be programmed. Make copies of the worksheets as necessary. Planning will make this process much faster and easier. Also, use the same worksheets to keep a permanent written record of your programming for each status channel.

Metering Channels

The VRC2000 has 16 metering channels (analog inputs). Metering channels operate somewhat like status channels, and are programmed similarly. However, each metering channel accepts an analog input. What the VRC2000 says when a metering channel is queried is user-programmable. The user also programs what calibration constants are used to derive reported values, time delays before alarms, and up to four tolerance levels for each metering channel; each metering channel can, in turn, generate alarms and activate automatic commands.

Metering channels act like direct current (DC) voltmeters or ammeters. They measure electromotive force over a 10V range, or direct current up to 10mA. This voltage scale can be programmed to read from 0–10Vdc, or from -5–5Vdc (sometimes referred to as the A–D range), or from 0–10mA, or from -5–5mA, all with respect to VRC2000 chassis ground.

Enter a "*" on the DTMF pad to program this metering channel to read a range from -5–5Vdc; enter a "#" to program it to read a range from 0–10Vdc.

Each metering channel's default parameters make it act like a unity gain amplifier; that is, the calibration constant for each metering channel is defaulted to 1.000. The default settings can be used to take accurate readings of voltage or current samples.

Metering Channel Settings

The VRC2000's metering channels can be set up for linear, indirect or power readings.

Linear Input. A metering channel defined as a linear input multiplies the sample voltage by the calibration constant. The VRC2000 will say [L] to indicate a linear configuration. Linear values are obtained by multiplying the input voltage (or current) values by the calibration constant.

$$\text{Linear value} = (\text{sample}) * (\text{calibration constant})$$

Indirect Input. A metering channel defined as an indirect input multiplies the two previous consecutive metering-channel readings together. Indirect

inputs are primarily used to calculate power readings (Power = Current * Voltage). The VRC2000 will say [I] to indicate an indirect configuration. Indirect values are obtained by multiplying the values of the two previous consecutive metering channels readings together. See the examples below.

Example 1

Indirect value for metering channel 3 =

*(sample for metering channel 1) * (calibration constant for metering channel 1)*

*

*(sample for metering channel 2) * (calibration constant for metering channel 2)*

*

calibration constant for metering channel 3

Example 2

Indirect value for metering channel 1 =

*(sample for metering channel 16) * (calibration constant for metering channel 16)*

*

*(sample for metering channel 15) * (calibration constant for metering channel 15)*

*

calibration constant for metering channel 1

CHANNELS 1 AND 2 NOTE:

As shown in Example 2, denoting an indirect value for metering channels 1 and 2 will result in calling up values from metering channels 15 and/or 16 (the two previous channels).

Power Readings. Metering channels defined as power readings mathematically square the input to the metering channel, then multiply the result by the calibration constant. The VRC2000 will say [P] to indicate a power configuration. Power readings automatically square the value of a metering channel's input sample.

Power values = $[(\text{sample}) * (\text{sample})] * (\text{calibration constant})$

METER CHANNEL OVERLOAD NOTE:

Be very careful not to overload any of the metering channels with excessive voltage or current. Overloads can seriously damage your VRC2000.

Calibration Constant and Tolerance Limits

Any mathematical value between -9,999 and 9,999 can be programmed into any metering channel *as the calibration constant*. This value must contain four digits, plus the decimal point.

SPOKEN NUMBER NOTE:

The VRC2000 can only say numbers ranging from -9,999 to 9,999. Use unit identifiers and calibration constants to convert the voltage or current readings on any metering channel into this range.

Use the calibration constant to obtain actual voltage or current readings based on a sample.

Example

If the voltage sample is 5V, which represents an actual value of 5,000V, program a calibration constant of 1,000. *Or* program a calibration constant of 1, and change the units identifier to KILO VOLTS. Since the largest number that the VRC2000 can say is 9,999, use the best combination of the calibration constant and the units identifier; this will result in information being reported clearly. Use “*” as the decimal point in *positive* numbers. Use “#” for the decimal point in *negative* numbers.

POSITIVE/NEGATIVE CONSTANT NOTE:

The VRC2000 obeys mathematical rules. A negative sample multiplied by a negative calibration constant results in a positive value. A positive sample multiplied by a negative calibration constant results in a negative value.

Tolerance Limits

Up to four tolerance limits for each metering channel can be programmed. Two of these limits must *always* be below the nominal value set for each metering channel; the other two must be above the nominal value. The second low limit refers to the *lowest tolerance limit* the metering channel will monitor; the second upper limit refers to the *highest tolerance limit*.

These tolerance limits can be programmed to automatically activate selected command channels, or to automatically call the outbound telephone numbers selected under the previous parameter, or both.

All tolerance limits must be set according to the result of the voltage or current sample for each metering channel and the associated calibration constant.

Just as with the calibration constant, program any number between -9,999 and 9,999 into any metering channel as a tolerance limit. Obviously, setting the *second low tolerance limit* for a metering channel at 9,999 will cause the VRC2000 to always generate an alarm if the alarm function for this tolerance limit is enabled. To disable the second low tolerance limit, set it at the lowest extreme number available (-9,999). On the other hand, if the *first high tolerance limit* for a metering channel is set at -9999, the VRC2000 will *always* generate an alarm if the alarm function for this tolerance limit is enabled. To disable the first high tolerance limit, set it at the highest number available (9,999).

Remember to use “*” as the decimal point in *positive* numbers (i.e. “5*125”=5.125), “#” for *negative* numbers (i.e. “7#85”=-7.85”). *This value must contain four digits, plus the decimal point.*

Setting Up Metering Channels

The programming steps for metering channels are necessarily more complicated than those of status channels. There are many more parameters to be programmed for each metering channel than for any status channel. Gentner Communications strongly recommends taking time to read this section and experiment with setting up several metering channels before deciding on the VRC2000's final programming parameters.

Use the VRC2000 to access a specific metering channel's set-up information. The VRC2000 begin list all available metering-channel functions. For each parameter, the VRC2000 will respond with a preprogrammed message, followed by the default parameter, followed by a [BEEP].

You enter

☛ "6 0 1"

The VRC2000 will respond:

- CHANNEL IDENTIFIER FOR METERING CHANNEL ONE IS ... {5 MILLISECONDS SILENCE, 5 MILLISECONDS SILENCE} ... [BEEP]

Two words from Appendix I: Word List ([See Page 125.](#)) can be programmed as the metering-channel identifier. The default setting for each metering Channel is two silences (which count as words).

- UNITS IDENTIFIER FOR METERING CHANNEL ONE IS ... {5 MILLISECONDS SILENCE, VOLTS} ... [BEEP]

Any metering channel can be programmed to identify its value in a combination of two words from Appendix I: Word List ([Page 125](#)). For example, the words [KILO VOLTS] or [MILLI AMPS] can be programmed as values.

- CONFIGURATION FOR METERING CHANNEL ONE IS ... {L} ... [BEEP]

Enter a "5" on the DTMF pad to configure this metering channel for *linear* readings. Enter a "4" on the DTMF pad to configure this metering channel for *indirect* readings. Enter a "7" for *power* readings.

The VRC2000 will say

- RANGE FOR METERING CHANNEL ONE IS ... {ZERO TO PLUS TEN} ... [BEEP]

Enter a "*" on the DTMF pad to program this metering channel to read a range from -5-5Vdc; enter a "#" to program it to read a range from 0-10Vdc.

- CALIBRATION CONSTANT FOR METERING CHANNEL ONE IS ... {ONE, POINT, ZERO, ZERO, ZERO} ... [BEEP]

When setting the tolerance limits for each metering channel, set them according the result of the calibration constant multiplied by the voltage or current sample.

- DEFAULT COMMAND CHANNEL FOR METERING CHANNEL ONE IS ... {DISABLED} ... [BEEP]

Any command channel can be tied to any metering channel. This allows commands to be issued directly, immediately after requesting metering-channel information.

When the VRC2000 has been accessed with the user access code, enter “*” to activate the A switch of the default command channel when you are reading metering channel 1. Enter “#” to activate the B switch of the default command channel when reading metering channel 1.

When programming this parameter, enter “0 0” to disable the default command channel for the selected metering channel. *Always use two digits to program this parameter.*

- ALARM DELAY FOR METERING CHANNEL ONE IS {ONE} ... [BEEP]

The time delay before alarms are generated and automatic commands are issued is user-programmable (from one second to 99 seconds). Alarm delays are handy in smoothing transients and time-based automatic functions. Once the alarm delay time passes, the unit will issue automatic commands until the metering channel’s input condition returns to a nominal (non-alarm) level. *Always use two digits to program this parameter.*

- PHONE NUMBER FOR METERING ALARM ONE IS ... {DIAL ALL} ... [BEEP]

The VRC2000 can be programmed to dial any single outbound telephone number or all of the outbound telephone numbers entered into the unit’s memory when an alarm on a metering channel is sensed. The default setting is {Dial All}, which indicates that the VRC2000 will dial, in sequence, all numbers presently entered into the unit’s outbound telephone number memory.

To set up the VRC2000 to dial all of the telephone numbers in sequence, program this parameter with a “0”. To program this parameter to dial a single outbound telephone number, enter the single-digit number which corresponds to the number you want the VRC2000 to dial. For example, to program the VRC2000 to dial outbound telephone number 1 when an alarm is generated by this metering channel, enter “1”.

- SECOND LOW LIMIT OF METERING CHANNEL ONE IS ... {MINUS, NINE THOUSAND, NINE HUNDRED, NINETY-NINE} ... [BEEP]

When setting tolerance limits for each metering channel, set them according the result of the calibration constant multiplied by the voltage or current sample.

- COMMAND CHANNEL NUMBER FOR SECOND LOW LIMIT OF METERING CHANNEL ONE IS ... {DISABLED} ... [BEEP]

This parameter allows a specific command channel to be selected in order to automatically activate if the second low tolerance limit on a metering channel is passed (i.e. an automatic command). Also select the switch to be fired for that command channel. Enter “#” to automatically activate the B

switch; enter “*” to automatically activate the A switch.

When programming this parameter, enter “0 0” to disable the automatic command channel assignment for the metering channel’s second low tolerance limit. *Always use two digits to program this parameter.*

- ALARM FOR SECOND LOW LIMIT OF METERING CHANNEL ONE IS ... {DISABLED} ... [BEEP]

The VRC2000 can be programmed to declare an alarm condition when the second low tolerance limit is passed on a metering channel. When programming the VRC2000, enter “#” to enable the alarm for this parameter; enter “*” to disable the alarm for this parameter.

- FIRST LOW LIMIT OF METERING CHANNEL ONE IS ... {MINUS, NINE THOUSAND, NINE HUNDRED, NINETY-NINE} ... [BEEP]

This parameter acts in the same way as the second low tolerance limit. This is the low value closest to the nominal value selected for the metering channel.

- COMMAND CHANNEL NUMBER FOR FIRST LOW LIMIT OF METERING CHANNEL ONE IS ... {DISABLED} ... [BEEP]

This parameter allows selection of the specific command channel to automatically activate if the first low tolerance limit is passed on a metering channel. This parameter functions and is programmed in the same way as the automatic command channel assignment for the second low tolerance limit. Also select the switch to be fired for that command channel (“#” to automatically activate the B switch; “*” to automatically activate the A switch).

- ALARM FOR FIRST LOW LIMIT OF METERING CHANNEL ONE IS ... {DISABLED} ... [BEEP]

The VRC2000 can be programmed to declare an alarm condition when the first low tolerance limit is passed on a metering channel. This parameter is programmed and functions just as with the alarm for the second low tolerance limit.

- FIRST HIGH LIMIT OF METERING CHANNEL ONE IS ... {NINE THOUSAND, NINE HUNDRED, NINETY-NINE} ... [BEEP]

To disable the *first high tolerance limit*, set it at the highest number available (9,999).

- COMMAND CHANNEL NUMBER FOR FIRST HIGH LIMIT OF METERING CHANNEL ONE IS ... {DISABLED} ... [BEEP]

This parameter is programmed and functions the same as the automatic command channel assignments for the second and first low tolerance limits.

This parameter allows selection of the specific command channel you would like to automatically activate if the first high tolerance limit is passed on a metering channel. Also select the switch to be fired for that command channel (“#” to automatically activate the B switch; “*” to automatically activate the A switch).

VRC2000 Setup
Continued 

- ALARM FOR FIRST HIGH LIMIT OF METERING CHANNEL ONE IS ... {DISABLED} ... [BEEP]

The VRC2000 can be programmed to declare an alarm condition when the first high tolerance limit is met on a metering channel.

- SECOND HIGH LIMIT OF METERING CHANNEL ONE IS ... {NINE THOUSAND, NINE HUNDRED, NINETY-NINE} ... [BEEP]

This parameter acts the same as the first high tolerance limit. This is the highest value allowed for the metering channel.

- COMMAND CHANNEL NUMBER FOR SECOND HIGH LIMIT OF METERING CHANNEL ONE IS ... {DISABLED} ... [BEEP]

This parameter allows the specific command channel to automatically activate if the second high tolerance limit is passed on a metering channel. You also select the switch to be fired for that command channel.

- ALARM FOR SECOND HIGH LIMIT OF METERING CHANNEL ONE IS ... {DISABLED} ... [BEEP]

The VRC2000 can be programmed to declare an alarm condition when the second high tolerance limit is passed on a metering channel.

There are 16 metering channels on a VRC2000. Each can be programmed with all the parameters outlined above. The metering channels are accessed with the codes listed in Table 8 (below):

Table 8. Metering Channel Access Codes

<u>You Enter</u>	<u>To Access Metering Channel</u>
☎ "6 0 1"	1
☎ "6 0 2"	2
☎ "6 0 3"	3
☎ "6 0 4"	4
☎ "6 0 5"	5
☎ "6 0 6"	6
☎ "6 0 7"	7
☎ "6 0 8"	8
☎ "6 0 9"	9
☎ "6 1 0"	10
☎ "6 1 1"	11
☎ "6 1 2"	12
☎ "6 1 3"	13
☎ "6 1 4"	14
☎ "6 1 5"	15
☎ "6 1 6"	16

METERING CHANNEL NOTE:

Notice that the "6" on your DTMF pad corresponds with the letter M. This is intended to help you remember that a code beginning with a "6" will program metering channels.

To program metering channels, first enter the appropriate code for the channel you would like to program. Immediately after the VRC2000 states its message, enter the desired set-up information. *All codes must be entered before the [BEEP].*

SINGLE BEEP NOTE:

The VRC2000 will emit a single [BEEP] after a set-up parameter if you do not make a new entry. If you do make a new entry after a set-up parameter is stated by the VRC2000, the unit will [BEEP] twice.

This process will proceed more quickly if the exact codes to be programmed are well planned. For this purpose, this manual includes worksheets in Appendix H: Setup Worksheets (Page 117).

Metering Channel Programming Exercise

The following exercise will illustrate more fully how to program metering channels.

Enter

☛ “6 0 1”

The VRC2000 will respond:

- CHANNEL IDENTIFIER FOR METERING CHANNEL ONE IS ... {5 MILLISECONDS SILENCE, 5 MILLISECONDS SILENCE}

Enter

☛ “6 0 8 7 7 1”

The VRC2000 will respond with a double [BEEP].

The VRC2000 is now programmed to say [PLATE VOLTAGE] when information about metering channel 1 is requested. Remember to enter the DTMF sequence *before* the double [BEEP] signal from the VRC2000.

The VRC2000 will say

- UNITS IDENTIFIER FOR METERING CHANNEL ONE IS ... {5 MILLISECONDS SILENCE, VOLTS }

You enter

☛ “0 4 7 7 7 2”

The VRC2000 responds with a double [BEEP].

This metering channel is now programmed to identify its units as [KILO VOLTS], although any two words from the word list can be entered as a units identifier.

The VRC2000 will say

- CONFIGURATION FOR METERING CHANNEL ONE IS ... {L }

VRC2000 Setup
Continued 

You enter

☛ “5”

The VRC2000 will respond with a double [BEEP].

This metering channel is now programmed to read in *linear values* (as a result of entering “5”). The VRC2000 will say [I] to indicate the *indirect* configuration; entering a “4” will configure this metering channel for indirect readings. The VRC2000 will say [P] to indicate the *power* configuration; entering a “7” will configure the metering channel for power readings.

The VRC2000 will say

- RANGE FOR METERING CHANNEL ONE IS ... {ZERO TO PLUS TEN}

You enter

☛ “#”

The VRC2000 will respond with a double [BEEP].

This metering channel is now programmed to read in a range of 0–10Vdc. Any metering channel can be programmed to read in a range of 0–10Vdc, or from -5–5Vdc. Enter a “*” to program this metering channel to read from -5–5Vdc; enter a “#” to read from 0–10Vdc.

The VRC2000 will say

- CALIBRATION CONSTANT FOR METERING CHANNEL ONE IS ... {ONE POINT ZERO ZERO ZERO}

You enter

☛ “3 * 1 4 2”

The VRC2000 will respond with a double [BEEP].

This metering channel is now configured to use the value +3.142 as the calibration constant.

Another option is to change the units identifier to make metering readings easier to understand. To use the calibration constant and/or units identifier to obtain actual voltage or current readings (based on a sample), refer to the following example.

The VRC2000 will say

- DEFAULT COMMAND CHANNEL FOR METERING CHANNEL ONE IS ... {DISABLED}

You enter

☛ “1 0”

The VRC2000 will respond with a double [BEEP].

The unit is now programmed to allow direct access to command channel 10 when information about metering channel 1 is requested. When the user access code has been entered, the "*" will activate command channel 10's A switch when accessing metering channel 1. Enter the "#" symbol to activate command channel 10's B switch when accessing metering channel 1.

When programming this parameter, enter "0 0" to disable the default command channel for the selected metering channel. *Always use two digits to program this parameter.*

The VRC2000 will say

- ALARM DELAY FOR METERING CHANNEL ONE IS ... {ONE}

You enter

☛ "1 0"

The VRC2000 will respond with a double [BEEP].

The alarm delay for this metering channel has now been set at 10 seconds. The alarm delay before alarms are generated and automatic commands are issued can be set for any value ranging from one second to 99 seconds. Once the alarm delay time passes, the unit will issue automatic commands until the metering channel's input condition returns to a nominal (non-alarm) level. An entry of "0 5" would program an alarm delay of five seconds; entering "8 5" sets it at 85 seconds. *Always use two digits to program this parameter.*

The VRC2000 will say

- PHONE NUMBER FOR METERING ALARM ONE IS ... {DIAL ALL}

You enter

☛ "0"

The VRC2000 will respond with a double [BEEP].

The VRC2000 is now programmed to dial all telephone numbers, in sequence, that have been entered into its memory. A metering channel can be programmed to dial any one of the five outbound telephone numbers currently stored in its memory, or all five of the outbound telephone numbers, when an alarm condition is generated by a metering channel. The VRC2000 will not begin dialing the outbound telephone numbers until the alarm delay has expired. The default setting for this function is {Dial All}.

To set up the VRC2000 to dial all of the telephone numbers in sequence, you program this parameter with a "0". To program this parameter to dial a single outbound telephone number, enter the single-digit number which corresponds to the number you want the VRC2000 to dial when it senses an alarm condition (i.e. to dial outbound telephone number 3 when, enter a "3".)

The VRC2000 will say

- SECOND LOW LIMIT OF METERING CHANNEL ONE IS ... {MINUS, NINE THOUSAND, NINE HUNDRED, NINETY-NINE}

VRC2000 Setup
Continued 

You enter

☛ “2 * 3 4 6”

The VRC2000 will respond with a double [BEEP].

The lowest tolerance limit has now been programmed with a value of 2.346. This is now the lowest value the metering channel will permit.

All tolerance limits must be set according to the result of the voltage or current sample for each metering channel and the associated calibration constant.

The VRC2000 will say

• COMMAND CHANNEL NUMBER FOR SECOND LOW LIMIT OF METERING CHANNEL ONE IS ... {DISABLED}

You enter

☛ “1 6”

The VRC2000 will respond with a double [BEEP].

Command channel 16 is now selected to automatically activate when the second low tolerance limit is met on this metering channel. This parameter allows the specific command channel to be automatically activated if the second low tolerance limit on a metering channel is passed to be selected. Also select the switch to be fired for that command channel.

When programming this parameter, enter “0 0” to disable the automatic command-channel assignment for the metering channel’s second low tolerance limit. *Always use two digits to program this parameter.*

When tying a command channel to a status channel (as in this example), the VRC2000 will say

• ACTIVE COMMAND CHANNEL SWITCH FOR SECOND LOW LIMIT OF METERING CHANNEL ONE IS ...

Since each command channel has two switches, now enter a code to instruct the VRC2000 whether to fire command channel 16’s A switch or the B switch when metering channel 1’s second low limit is passed.

You enter

☛ “#”

The VRC2000 will respond with a double [BEEP].

The VRC2000 is now programmed to automatically fire command channel 16’s B switch when the second low tolerance limit for metering channel 1 is met. Entering “#” indicates the B switch; entering “*” indicates the A switch.

The VRC2000 will respond:

- ALARM FOR SECOND LOW LIMIT OF METERING CHANNEL ONE IS ... {DISABLED}

You enter

☛ “#”

The VRC2000 will respond with a double [BEEP].

The VRC2000 will now declare an alarm condition when the second low tolerance limit is met on this metering channel. When programming the VRC2000, enter a “#” to enable the alarm for this parameter; enter a “*” to disable the alarm.

The VRC2000 will say

- FIRST LOW LIMIT OF METERING CHANNEL ONE IS ... {MINUS, NINE THOUSAND, NINE HUNDRED, NINETY-NINE}

You enter

☛ “1 * 3 4 6”

The VRC2000 will respond with a double [BEEP].

The value of the first low tolerance limit is now set at 1.346. *The “*” indicates a decimal point in a positive number.*

The VRC2000 will say

- COMMAND CHANNEL NUMBER FOR FIRST LOW LIMIT OF METERING CHANNEL ONE IS ... {DISABLED}

You enter

☛ “1 5”

The VRC2000 will respond with a double [BEEP].

Command channel 15 is now set to automatically activate when this metering channel’s first low tolerance limit is passed. When an automatic command channel assignment is made (as in this example), the VRC2000 will continue with the following

- ACTIVE COMMAND CHANNEL SWITCH FOR FIRST LOW LIMIT OF METERING CHANNEL ONE IS ...

Since each command channel has two switches, now enter a code to tell the VRC2000 whether to fire command channel 15’s switch A or switch B when metering channel 1’s first low limit is passed.

You enter

☛ “*”

VRC2000 Setup
Continued 

The VRC2000 will respond with a double [BEEP].

The VRC2000 is now set to automatically fire command channel 15's A switch when metering channel 1's first low tolerance limit is passed.

Entering "*" indicates A switch; "#" indicates the B switch.

The VRC2000 will say

- ALARM FOR FIRST LOW LIMIT OF METERING CHANNEL ONE IS ... {DISABLED}

You enter

☛ "*"

The VRC2000 will respond with a double [BEEP].

The alarm for the first low tolerance limit on metering channel 1 is now disabled. Entering "*" here disables the alarm for this tolerance limit; "#" enables the alarm for this tolerance limit.

The VRC2000 will say

- FIRST HIGH LIMIT OF METERING CHANNEL ONE IS ... {NINE THOUSAND, NINE HUNDRED, NINETY-NINE}

You enter

☛ "5 * 2 5 5"

The VRC2000 will respond with a double [BEEP].

The first high tolerance limit for metering channel 1 is now set at 5.255. *The "*" indicates a decimal point in a positive number.*

The VRC2000 will say

- COMMAND CHANNEL NUMBER FOR FIRST HIGH LIMIT OF METERING CHANNEL ONE IS ... {DISABLED}

You enter

☛ "1 3"

The VRC2000 will respond with a double [BEEP].

Command channel 13 is now selected to automatically activate when the first high tolerance limit is met on this metering channel. When tying a command channel to a metering channel (as in this example), the VRC2000 will continue with the following

- ACTIVE COMMAND CHANNEL SWITCH FOR FIRST HIGH LIMIT OF METERING CHANNEL ONE IS ...

Since each command channel has two switches, now enter a code to tell the VRC2000 which switch on command channel 13 to automatically fire when the first high limit for metering channel 1 is passed.

You enter

☛ “#”

The VRC2000 will respond with a double [BEEP].

The VRC2000 is now set to automatically fire command channel 16's B switch when metering channel 1's first high tolerance limit is passed. Entering “#” indicates the B switch; “*” indicates the A switch.

The VRC2000 will say

- ALARM FOR FIRST HIGH LIMIT OF METERING CHANNEL ONE IS ... {DISABLED}

You enter

☛ “#”

The VRC2000 will respond with a double [BEEP].

The VRC2000 will now declare an alarm condition when metering channel 1's first high tolerance limit is passed.

The VRC2000 will say

- SECOND HIGH LIMIT OF METERING CHANNEL ONE IS ... {NINE THOUSAND, NINE HUNDRED, NINETY-NINE}

You enter

☛ “7 * 1 2 3”

The VRC2000 will respond with a double [BEEP].

The second high tolerance limit is now set at 7.123. This is the highest value allowed for this metering channel (“*” indicates a decimal point in a positive number; “#” indicates the decimal in a negative number).

The VRC2000 will say

- COMMAND CHANNEL NUMBER FOR SECOND HIGH LIMIT OF METERING CHANNEL ONE IS ... {DISABLED}

You enter

☛ “0 0”

The VRC2000 will respond with a double [BEEP].

The command-channel assignment for metering channel 1's second high tolerance limit is now disabled. As a result, no automatic commands will issue when this tolerance limit is exceeded, and the VRC2000 will not request selection of a command channel switch to activate.

The VRC2000 will say

- ALARM FOR SECOND HIGH LIMIT OF METERING CHANNEL ONE IS ... {DISABLED}

You enter

☛ “#”

The VRC2000 will respond with a double [BEEP].

The VRC2000 will now declare an alarm condition when metering channel 1’s second high tolerance limit is met. Entering “#” enables the alarm; “*” disables the alarm.

Now program metering channels with your own information. Use the planning worksheets (See [Appendix H: Setup Worksheets, Page 117.](#)) to plan the exact codes to be programmed. Planning will make this process much faster and easier. These worksheets also function as a permanent written record of metering-channel programming.

Setting Up Command Channels

The VRC2000 has 16 command channels which can turn equipment on or off, raise/lower power or voltage settings on site equipment, or anything else controllable through the open collector output switches on the VRC2000’s rear panel.

If open collectors are not adequate for site-control needs, use the Command Relay Unit (See [Appendix C: Accessories, Page 100.](#)), which converts the open collector outputs of up to eight command channels to relay contact closures. Each relay in the Command Relay Unit is rated for up to 5A, at up to 240V.

Any status or metering channel can be programmed to automatically activate a particular command-channel switch. Commands can also be issued directly to any command channel via DTMF telephone.

Each command channel has two switch outputs, labeled A and B. The switch outputs are open collectors, which can be programmed either as momentary or latching.

In the *latching* configuration, when switch A is activated, switch B will always be deactivated, and vice versa. In other words, either switch B or contact A will *always* be activate. Latching command-channel switches are often used as toggle switches for certain types of site equipment.

Momentary switches may be set up to activate for periods of time ranging from one-eighth of a second to 31.875 seconds. The default setting for all open collectors is momentary, with one-half second duration. *Switches A and B cannot be ON at the same time.*

For command-channel electrical specifications, see Specifications (Page 91).

Programming command channels is similar programming status and metering channels; however, take time to read this section and experiment with setting up several command channels *before* deciding on final programming.

First, access a command channel’s set-up information. The VRC2000 will list the available functions for the command channel. For each parameter,

the VRC2000 will respond with a preprogrammed message, followed by the default parameter, then a [BEEP]. Any default parameter (enclosed in braces { }) can be changed when setting up the VRC2000.

You enter

☛ “2 0 1”

The VRC2000 will respond:

- CHANNEL IDENTIFIER FOR COMMAND CHANNEL ONE IS {5MILLISECONDS SILENCE, 5 MILLISECONDS SILENCE} ... [BEEP]

Two words from the VRC2000 word list (See Appendix I.) can be programmed for the unit’s command-channel identifier. The default setting for each command channel is two five-millisecond silences. The silences do count as words.

- CONFIGURATION FOR COMMAND CHANNEL ONE IS ... {M} ... [BEEP]

Each command channel to be either latching or momentary. If a command channel is set up to be *momentary*, the unit will say [M]; if set up to be *latching*, the VRC2000 will say [L]. If momentary, program an active delay time (the time in which the switch is active) for that command channel; if latching, either the A or B switch will *always* be energized. Use the “*” symbol to program command channel switches as momentary; the “#” symbol programs command-channel switches as latching.

- SWITCH A IDENTIFIER FOR COMMAND CHANNEL ONE IS ... {A ACTIVATED} ... [BEEP]

Each command channel has two switches (A and B). The unit can be programmed to identify each switch with up to two words from the VRC2000 word list (Appendix H).

- SWITCH B IDENTIFIER FOR COMMAND CHANNEL ONE IS {B ACTIVATED} ... [BEEP]

- ACTIVE DELAY FOR COMMAND CHANNEL ONE IS ... {FOUR} ... [BEEP]

This parameter adjusts the length of each command channel’s momentary closure. The number to be programmed represents the number of *one-eighth seconds* to activate a momentary switch. For example, the {Four} default setting indicates that the momentary closure will last one-half second.

If a command channel is programmed as latching, one switch or the other will always be activated. The unit will not allow programming of the active delay parameter if the command channel is latching. *Use three digits to program this parameter.* For example, entering “0 0 8” would program an active delay of one second.

There are 16 command channels, each with an A and a B switch, on the VRC2000. Each one can be programmed with all the parameters listed above. The command channels are accessed with the codes listed in Table 9 ([next page, top](#)).

VRC2000 Setup
Continued 

Table 9. Command Channel Access Codes

<u>You Enter</u>	<u>To Access Command Channel</u>
☛ “2 0 1”	1
☛ “2 0 2”	2
☛ “2 0 3”	3
☛ “2 0 4”	4
☛ “2 0 5”	5
☛ “2 0 6”	6
☛ “2 0 7”	7
☛ “2 0 8”	8
☛ “2 0 9”	9
☛ “2 1 0”	10
☛ “2 1 1”	11
☛ “2 1 2”	12
☛ “2 1 3”	13
☛ “2 1 4”	14
☛ “2 1 5”	15
☛ “2 1 6”	16

COMMAND CHANNEL CODE NOTE:

The “2” on the DTMF pad corresponds to the letter C. This is intended to help you remember that codes starting with a “2” program VRC2000 command channels.

To program command channels, enter the appropriate access code. Immediately after the VRC2000 responds, enter the set-up information to be programmed into the unit. *Enter information before the [BEEP] signal from the VRC2000.*

SINGLE BEEP NOTE:

The VRC2000 will emit a single [BEEP] after a set-up parameter if you do not make a new entry. If you do make a new entry after a set-up parameter is stated by the VRC2000, the unit will [BEEP] twice.

This process will run more quickly and smoothly if the exact codes to be programmed into each command channel are well planned. Worksheets in Appendix H (See Page 117.) will aid in the planning process.

Command Channel Programming Exercise

The following command-channel programming exercise will illustrate more fully how to program command channels.

Enter

☛ “2 0 1”

The VRC2000 will respond:

- CHANNEL IDENTIFIER FOR COMMAND CHANNEL ONE IS ... {5 MILLISECONDS SILENCE, 5 MILLISECONDS SILENCE }

You enter

☛ “6 0 8 7 7 1”

The VRC2000 will respond with a double [BEEP].

The VRC2000 will now say [PLATE VOLTAGE] when a command is issued to command channel 1.

The VRC2000 will say

- CONFIGURATION FOR COMMAND CHANNEL ONE IS ... {M}

You enter

☛ “*”

The VRC2000 will respond with a double [BEEP].

The switches for command channel 1 are now set to be momentary. Use “*” to program command-channel switches as momentary, “#” latching.

The VRC2000 will say

- SWITCH A IDENTIFIER FOR COMMAND CHANNEL ONE IS ... {A ACTIVATED}

You enter

☛ “6 3 4 7 7 1”

The VRC2000 will respond with a double [BEEP].

The VRC2000 will now say [RAISE VOLTAGE] when switch A for command channel 1 is energized.

The VRC2000 will say

- SWITCH B IDENTIFIER FOR COMMAND CHANNEL ONE IS ... {B ACTIVATED}

You enter

☛ “5 2 9 7 7 1”

The VRC2000 will respond with a double [BEEP].

The VRC2000 will now say [LOWER VOLTAGE] when switch B for command channel 1 is activated.

The VRC2000 will say

- ACTIVE DELAY FOR COMMAND CHANNEL ONE IS ... {FOUR}

You enter

☛ “0 0 8”

The VRC2000 will respond with a double [BEEP].

Both switches for command channel 1 are now programmed to close for one second and then release. The active-delay function applies in this example because this command channel as *momentary*. The active-delay function causes the switches to energize for a programmed length of time when activated either manually or by automatic command.

When ready to begin final setup of command channels, use the worksheets in Appendix H (See Page 117.) to plan the exact set-up information to be entered for each parameter. Planning will make this process faster and easier. Also, use the same worksheets to keep a permanent written record of command-channel programming.

Give some thought to exactly how the command channels should interface with site equipment. Experiment before settling on final programming and interface scheme. At the same time, it is easy to change VRC2000 programming — setting parameters will not lock your site into a particular configuration.

Setting Time-Of-Day Functions

Up to 64 time-of-day functions can be programmed into the VRC2000. Time-of-day functions are based on a 24-hour clock, and can be used to automatically activate any of the command channels' 32 switches.

Time-of-day functions may be set to occur

- daily, at a specific time of day
- on a specific day of the year, at a specific time of day
- weekly, at a specific time of day
- every day, at a specific time of day for a particular month.

Typical uses for time-of-day functions in broadcast applications include automatic power-level changes at dusk and dawn, and antenna pattern changes.

All time-of-day functions are disabled when the VRC2000 is shipped from the factory.

The programming steps for the time-of-day functions are simple; however, read this section and experiment with setting up several time-of-day functions before deciding on the final VRC2000 programming.

First, access set-up information about a particular time-of-day function for a listing of the options and functions available for each time-of-day function. For each parameter, the VRC2000 will respond with a preprogrammed message, followed by the default parameter (in braces { }), followed by a [BEEP]. Any default parameters can be changed when setting up the VRC2000.

You enter

☛ “3 0 1 *”

The VRC2000 will respond:

• TIME-OF-DAY HOURS FOR ENTRY ONE ARE ... {DISABLED}

DEFAULT SETTING NOTE:

As shipped from the factory, all time-of-day functions are disabled.

Enter a “#” symbol after the code to enable that time-of-day function. Entering “#” will also allow programming of the selected time-of-day function. Entering a “*” symbol will disable the selected time-of-day function.

There are 64 time-of-day function entries available on your VRC2000. The metering channels are accessed with the codes listed in Table 10 (below).

Table 10. Time-Of-Day Function Access Codes

<u>You Enter</u>	<u>To Access Time-Of-Day Function</u>
☛ “3 0 1”	1
☛ “3 0 2”	2
☛ “3 0 3”	3
☛ “3 0 4”	4
☛ “3 0 5”	5
☛ “3 0 6”	6
☛ “3 0 7”	7
☛ “3 0 8”	8
☛ “3 0 9”	9
☛ “3 1 0”	10
<i>(continuing through)</i>	
☛ “3 6 2”	62
☛ “3 6 3”	63
☛ “3 6 4”	64

To program a time-of-day function, first enter the appropriate access code, then enter a “#”. Immediately after the VRC2000 responds, enter desired set-up information. *Enter your information before the VRC2000 emits a single [BEEP].*

This process run more quickly and easily if exact codes to be programmed into each time-of-day entry are well planned. Worksheets supplied in Appendix H (See Page 117.) will help in the planning process.

Entering Time/Date On Time-Of-Day Functions

The time in which a time-of-day function activates *must* include two digits, be it the month, hour, minute or second.

Example

Entering “0 3” would mean the third month (March), third day, third hour,

third minute or third second (depending on which parameter is being programmed). Entering “1 1” would indicate the eleventh month (November), eleventh day, eleventh hour, eleventh minute or eleventh second.

Time-Of-Day Function Programming Exercise

The following time-of-day function programming exercise will illustrate more fully how to program time-of-day functions.

TIME-OF-DAY PROGRAMMING NOTE:

The “#” symbol must be entered after the proper access code in order to program time-of-day functions. Entering the “” symbol after the time-of-day function access code will disable that time-of-day function.*

The VRC2000 will emit only a single [BEEP] after a set-up parameter if you do not make a new entry. If you do make a new entry, the VRC2000 will [BEEP] twice.

Enter

☛ “3 0 1 #”

The VRC2000 will respond:

• TIME-OF-DAY HOURS FOR ENTRY ONE ARE ... {TEN}

You enter

☛ “0 6”

The VRC2000 will respond with a double [BEEP].

The time-of-day function entry one is now set to activate at the sixth hour on the clock. *Two digits must be entered for all time-of-day functions, including any leading zeros.*

The VRC2000’s real-time clock expresses time in a 12-hour format. Whether the hour entered is for AM (before noon) or PM (after noon) must be specified.

The VRC2000 will say

• TIME-OF-DAY MINUTES FOR ENTRY ONE ARE ... {TEN}

You enter

☛ “3 0”

The VRC2000 will respond with a double [BEEP].

Time-of-day function entry one is now set to activate at the thirtieth minute of the selected hour.

The VRC2000 will say

- TIME-OF-DAY SECONDS FOR ENTRY ONE ARE ... {TEN}

You enter

☛ “4 5”

The VRC2000 will respond with a double [BEEP].

Time-of-day function entry one is now set to activate at the forty-fifth second of the selected minute and hour.

The VRC2000 will say

- TIME-OF-DAY FOR ENTRY ONE IS ... {AM}

You enter

☛ “#”

The VRC2000 will respond with a double [BEEP].

Time-of-day function entry one is now set to activate during the after noon (PM) portion of the day. In this example, the time selected is 6:30:45 p.m. Use “#” to program the time-of-day function to activate during the afternoon (PM), “*” to program the time-of-day function to activate before noon (AM).

The VRC2000 will say

- TIME-OF-DAY DATE FOR ENTRY ONE IS ... {OCTOBER}

You enter

☛ “0 9”

The VRC2000 will respond with a double [BEEP].

Time-of-day function entry one is now set to activate on a day in September.

DATE VS. MONTH NOTE:

The VRC2000’s word list does not contain the word “month.” Therefore, this parameter uses the word [DATE] to prompt and entry for what month a time-of-day function should activate.

To disable the date parameter, enter “0 0”. To activate time-of-day functions weekly, the date parameter *must* be disabled.

If the date function is disabled, the VRC2000 will say

- DAY OF WEEK FOR ENTRY ONE IS ... {DISABLED}

You enter

☛ “4”

VRC2000 Setup
Continued 

The VRC2000 will respond with a double [BEEP].

Time-of-day function one is now set to activate on Wednesday; that is, the fourth day of the week. Use a *single digit* to enter the day of the week for a time-of-day function.

To disable the day-of-the-week parameter, enter a “0”. To activate a time-of-day function *every day*, the day-of-the-week function *must* be disabled.

The VRC2000 will say

- TIME-OF-DAY DAY FOR ENTRY ONE IS ... {TEN}

You enter

◀ “0 7”

The VRC2000 will respond with a double [BEEP].

Time-of-day function one is now set to activate at the seventh day of the selected month. For this example, the VRC2000’s time-of-day function entry one to is set to activate at 6:30:45 p.m. on September 7.

The VRC2000 will say

- COMMAND CHANNEL NUMBER FOR ENTRY ONE IS ... {ONE}

You enter

◀ “0 4”

The VRC2000 will respond with a double [BEEP].

When the VRC2000 executes time-of-day function entry one, it will now trigger command channel 4 at 6:30:45 p.m. on September 7. Always use two digits to enter the command channel number for a time-of-day function.

The VRC2000 will say

- ACTIVE COMMAND CHANNEL SWITCH FOR ENTRY ONE IS ... {A ACTIVATED}

SWITCH IDENTIFIER NOTE:

The VRC2000 will speak whatever words programmed to identify the active command channel switch for a time-of-day function entry.

You enter

◀ “*”

The VRC2000 will respond with a double [BEEP].

When the VRC2000 executes time-of-day function entry one, it will now activate command channel 4’s A switch at 6:30:45 p.m. on September 7. Enter a “*” to specify switch A for the selected command channel; enter a “#” symbol to specify switch B.

For further practice setting up time-of-day functions, refer to Appendix G: Time-Of-Day Function Tutorial ([Page 114](#)).

When ready to begin final setup of time-of-day functions, use the worksheets in Appendix H ([See Page 117](#).) plan the exact codes to be entered for each time-of-day function parameter. Careful planning will make this process faster and easier. Use the same worksheets to keep a permanent written record of time-of-day function programming.

Setting Up Mute Functions

The VRC2000 has 40 mute-function entries. Mute functions will disable all alarms and automatic commands associated with any status channel or metering channel. Mute functions can activated by any status channel. A mute function will disable itself when the status channel that is programmed to control the mute function changes back to its original state.

Mute functions can be very helpful in broadcast applications where circumstances require changing transmitters. With the mute functions, those alarms that do not apply to the new transmitter can be muted or disarmed. The default setting (in braces { }) for each mute function entry is disabled.

Programming mute functions is similar to setting up time-of-day functions. Please read this section and experiment with setting up several mute functions before deciding on final VRC2000 programming.

First, access a particular mute-function entry's set-up information. The VRC2000 will list the options and functions available for each parameter, giving a preprogrammed message, followed by the default parameter, followed by a [BEEP]. Any default parameters can be changed when setting up the VRC2000.

You enter

☛ "4 0 1 *"

The VRC2000 will respond:

- STATUS CHANNEL NUMBER FOR DISARM ONE IS ... {DISABLED}

DEFAULT MUTE FUNCTION NOTE:

As shipped from the factory, all VRC2000 mut functions are disabled.

Enter a "#" after the code for the selected mute function to enable that mute function. The "#" entry also allows the selected mute function's parameters to be programmed. Entering a "*" symbol disables the selected mute function.

The 40 mute-function entries are accessed with the codes listed in Table 11 ([next page, top](#)).

VRC2000 Setup

Continued **Table 11. Mute Function Access Codes**

<u>You Enter</u>	<u>To Access Mute Function</u>
☛ “4 0 1”	1
☛ “4 0 2”	2
☛ “4 0 3”	3
☛ “4 0 4”	4
☛ “4 0 5”	5
☛ “4 0 6”	6
☛ “4 0 7”	7
☛ “4 0 8”	8
☛ “4 0 9”	9
☛ “4 1 0”	10
<i>(continuing through)</i>	
☛ “4 3 8”	38
☛ “4 3 9”	39
☛ “4 4 0”	40

To program a mute function, first enter the appropriate code for the entry to be programmed, followed by a “#” symbol. Immediately after the VRC2000 responds, enter the set-up information to be programmed. *Enter the information before the VRC2000 emits a single [BEEP].*

SINGLE BEEP NOTE:

The VRC2000 will emit a single [BEEP] after a set-up parameter if you do not make a new entry. If you do make a new entry after a set-up parameter is stated by the VRC2000, the unit will [BEEP] twice.

This process will proceed more quickly if the exact codes to be programmed into each mute-function entry are well planned. Worksheets supplied in Appendix H (See Page 117.) will aid in the planning process.

Mute Function Programming Exercise

The following mute-function programming exercise will illustrate more fully how to program mute functions.

Enter

☛ “4 0 1 #”

MUTE FUNCTION PROGRAMMING NOTE:

The “#” symbol must be entered after the proper access code when setting up mute functions. Entering a “” symbol will disable the selected mute function.*

The VRC2000 will respond:

- STATUS CHANNEL NUMBER FOR DISARM ONE IS ... {ONE}

You enter

☛ “0 2”

The VRC2000 will respond with a double [BEEP].

Status channel 2 will now activate mute-function entry one. *Use two digits to program the status-channel number for a mute function.*

The VRC2000 will say

- STATUS CHANNEL CONDITION FOR DISARM ONE IS ... {INPUT CLOSED}

You enter

☛ “*”

The VRC2000 will respond with a double [BEEP].

Mute-function entry one will now be activated by status channel 2 going *low*. The VRC2000 will use the words programmed to identify status channel 2's low state.

Enter a “*” symbol to program the mute function for the selected status channel's low state. Enter a “#” symbol to program the mute function for the status channel's high state.

The VRC2000 will say

- CHANNEL FOR DISARM ONE IS ... {METERING}

You enter

☛ “#”

The VRC2000 will respond with a double [BEEP].

Mute-function entry one is now set to mute (disarm), a metering channel. The mute function will be activated by status channel 2 going low. *All alarms and automatic commands associated with the selected metering channel will be defeated as long as the mute function is active.* Enter a “#” symbol to program the mute function to mute (disarm) a metering channel; enter a “*” symbol to program the mute function to mute a status channel.

The VRC2000 will say

- CHANNEL NUMBER FOR DISARM ONE IS ... {ONE}

You enter

☛ “0 9”

The VRC2000 will respond with a double [BEEP].

Mute-function entry one will now be activated by status channel 2 going low; it will mute (disarm) metering channel 9. Use two digits to enter the number of the status or metering channel to be muted (disarmed).

When ready to begin final setup of mute functions, use the worksheets in Appendix H (See Page 117.) to plan the exact set-up information to be entered for each parameter. Proper planning will make this process faster and easier. Also, use the same worksheets as a permanent written record of programming for each mute-channel entry.

Setting Up Sequence Output Programs

The VRC2000 allows four separate sequences (each consisting of up to 32 keystrokes), to be called up with simple sets of three DTMF entries. This mini-program, which can be replayed at any time with the proper code, works something like an automatic telephone dialer.

Gentner Communications recommends that sequence-output programs *only* be used to take readings from the status and metering channels, check the real-time clock, and/or check for pending alarms.

Four sequence-output programs are available on the VRC2000. As shipped from the factory, these sequence-output programs are empty.

Programming sequence-output programs is simple. Nevertheless, read this section and experiment with setting up a sequence-output program a few times before deciding on the final VRC2000 programming.

First, access a sequence-output program's default set-up information. For each parameter, the VRC2000 will respond with a preprogrammed message, followed by the default parameter (in braces { }), followed by a [BEEP]. Any default parameter can be changed when setting up the VRC2000.

You enter

☛ "5 0 1"

The VRC2000 will respond:

- SEQUENCE ONE IS ... {DISABLED} ... [BEEP]

To change the setup for the first sequence-output program, enter set-up mode, then enter a "5 0 1" access code, then the code numbers to be programmed into the sequence-output program.

Each sequence-output program allows up to 32 digits to be entered. If a sequence-output program contains less than 32 digits, end it with the DTMF sequence "8 8 8".

To disable a sequence output, enter the access code for the selected sequence-output program, followed by "8 8 8". This erases all previous programming for the selected sequence-output program and enters an empty sequence.

Sequence Output Programming Exercise

The following sequence-output programming exercise will illustrate more fully how to program sequence outputs. The exercise will set up a sequence-output program to check the real-time clock, take readings on status channels 1, 5 and 6, and metering channels 2, 4 and 16. *You must be in set-up mode to change sequence-output programs.*

First, enter

☛ “5 0 1”

Then enter the commands in Table 12 (below).

Table 12. Sequence Output Programming Exercise

<u>You enter</u>	<u>Sequence Description</u>
☛ “0 6 0”	Check real-time clock
☛ “7 0 1 *”	Read state of status channel 1
☛ “7 0 5 *”	Read state of status channel 5
☛ “7 0 6 *”	Read state of status channel 6
☛ “6 0 2 *”	Check metering channel 2
☛ “6 0 4 *”	Check metering channel 4
☛ “6 1 6 *”	Check metering channel 16
☛ “8 8 8”	This sequence-output program contains less than 32 digits; thus, it ends with “8 8 8”

If the “0 0 0” code is included, all pending alarms will be read by a sequence-output program. If including this command in the sequence output, always put it at the end of the complete sequence (before “8 8 8”, if required).

Sequence-output programs can check a selection of status and metering channels without having to enter the complete tone sequence. In this case, they can be used for routine checks on site equipment.

All four sequence-output programs available on the VRC2000 are accessed for programming with the codes listed in Table 13 (below).

Table 13. Sequence-Output Program Access Codes

<u>You Enter</u>	<u>To Access Sequence Output Number</u>
☛ “5 0 1”	Sequence 1
☛ “5 0 2”	Sequence 2
☛ “5 0 3”	Sequence 3
☛ “5 0 4”	Sequence 4

Two or more sequence-output programs can be linked together by entering another sequence-output program’s access code in the set-up sequence.

Any sequence-output program can be stopped while it is functioning by pressing any DTMF digit. The VRC2000 will stop the sequence-output program and wait for the next command to be entered on the DTMF pad. *You must be in user or operator mode to activate a sequence-output program.*

When ready to begin final setup of sequence-output programs, use the worksheets in Appendix H (See Page 117.) to plan the exact codes to be entered. Planning will make this process faster and easier. Also, use the same worksheets to keep a permanent written record of sequence-output programming.

Setting Up Auto-Logging Functions

If your VRC2000 is equipped with a Data Interface, the system can be set up to automatically dial an outbound telephone number (or key on a two-way radio system), turn on the Data Interface, and transmit all metering and status-channel readings and the current state of the command channels to an attached PC running Setup VRC2000 software in terminal mode, or VRC-Win software. The system can be programmed to auto-log at regular intervals ranging from every 15 minutes to once a day.

Refer to the Data Interface Installation and Operations Manual, Setup VRC2000 Installation and Operations Manual, and/or VRC-Win Installation and Operations Manual for more information about auto-logging.

The VRC2000 programming steps to set-up auto-logging are simple. Read this section and experiment with setting up auto-logging a few times before deciding on the final VRC2000 programming.

First, access the default set-up information for the auto-logging function. For each parameter, the VRC2000 will respond with a preprogrammed message, followed by the default parameter (in braces { }), followed by a [BEEP]. Any default parameter can be changed when setting up the VRC2000.

You enter

☛ “0 2 0 #”

The VRC2000 will respond:

- TIME-OF-DAY HOURS FOR LOGGING START TIME ARE ... {TWELVE} ... [BEEP]
- TIME-OF-DAY MINUTES FOR LOGGING START TIME ARE ... {ZERO} ... [BEEP]
- TIME OF DAY FOR LOGGING START IS ... {AM} ... [BEEP]
- TIME-OF-DAY HOURS FOR LOGGING STOP TIME ARE ... {TWELVE} ... [BEEP]
- TIME-OF-DAY MINUTES FOR LOGGING STOP TIME ARE ... {ZERO} ... [BEEP]
- TIME OF DAY FOR LOGGING STOP IS ... {AM} ... [BEEP]
- LOGGING REPEAT TIME HOURS ARE ... {ZERO} ... [BEEP]
- LOGGING REPEAT TIME MINUTES ARE ... {FIFTEEN} ... [BEEP]

To change the auto-logging function, you must be in the set-up mode, then enter “0 2 0 #” access code, followed by the code numbers to be programmed for the auto-logging function. *Two digits must be entered for any time entries required for the auto-logging function.* Enter the “*” symbol to indicate AM (before noon); the “#” indicates PM (after noon).

AUTO-LOGGING NOTE:

The VRC2000 will auto-log only to the first outbound telephone number set up to use phone modem or radio modem output configuration. If using the auto-logging function, Gentner Communications recommends programming outbound telephone number 1 in either phone modem or radio modem output configuration to force the VRC2000 to use this number for auto-logging. Doing so also

ensures that alarm logs are always reported before being cleared.

Auto-Logging Programming Exercise

The following autologging programming exercise will illustrate more fully how to program auto-logging. The exercise entails setting the auto-logging function to begin generation logs at 6:05 a.m. every day, and stop generating logs at 7:45 p.m. every evening; the logs will be generated every 90 minutes.

AUTO-LOGGING PROGRAMMING NOTE:

You must be in the set-up mode in order to change the set up for an auto-logging function.

AUTO-LOGGING TIME NOTE:

The interval for auto-logging cannot cross midnight. In other words, logging cannot run from 7:45 p.m.–6:05 a.m. (for example).

First, enter

☛ “0 2 0 #”

The VRC2000 will respond

• TIME-OF-DAY HOURS FOR LOGGING START TIME ARE ... {TWELVE}

You enter

☛ “0 6”

The VRC2000 will respond with a double [BEEP].

Auto-logging will now start at the sixth hour of the day.

TIME NOTE:

Enter two digits for all time entries.

The VRC2000 will say

• TIME-OF-DAY MINUTES FOR LOGGING START TIME ARE ... {ZERO}

You enter

☛ “0 5”

The VRC2000 will respond with a double [BEEP].

Auto-logging will now start at the fifth minute of the selected hour.

The VRC2000 will say

• TIME-OF-DAY FOR LOGGING START IS ... {AM}

You enter

☛ “*”

VRC2000 Setup
Continued 

The VRC2000 will respond with a double [BEEP].

Auto-logging is programmed to occur before noon (AM). Use “*” to select AM; “#” selects PM.

The VRC2000 will say

• TIME-OF-DAY HOURS FOR LOGGING STOP TIME ARE ... {TWELVE}

You enter

☛ “0 7”

The VRC2000 will respond with a double [BEEP].

Auto-logging will now stop at the seventh hour of every day.

The VRC2000 will say

• TIME-OF-DAY MINUTES FOR LOGGING STOP TIME ARE ... {FIFTY-NINE}

You enter

☛ “3 5”

The VRC2000 will respond with a double [BEEP].

Auto-logging will now stop at the 35th minute of the selected hour.

The VRC2000 will say

• TIME OF DAY FOR LOGGING STOP IS {AM}

You enter

☛ “#”

The VRC2000 will respond with a double [BEEP].

Auto-logging will now stop after noon (PM). Enter “#” to select PM; use “*” to select AM.

The VRC2000 will say

• LOGGING REPEAT TIME HOURS ARE ... {ZERO}

You enter

☛ “0 1”

The VRC2000 will respond with a double [BEEP].

The auto-logging function will now generate a new auto-log at least once every hour.

The VRC2000 will say

- LOGGING REPEAT TIME MINUTES ARE ... {FIFTEEN}

You enter

☛ “3 0”

The VRC2000 will respond with a double [BEEP].

The auto-logging function will now generate a new auto-log once every 90 minutes.

To disable the auto-logging function, enter

☛ “0 2 0 *”

The VRC2000 will respond

- LOGGING IS DISABLED

DATA INTERFACE NOTE:

A Data Interface must be installed in the VRC2000 in order to use the auto-logging function. Refer to the Data Interface Installation and Operations Manual, Setup VRC2000 Installation and Operations Manual and/or VRC-Win Installation and Operations Manual for more information about how to set up a control site to accept auto-logs from the VRC2000.

Clearing All Programming

Once the VRC2000 programming is planned in its entirety, you may desire to clear all practice/exercise programming from the VRC2000 and start from scratch. To do this, remove AC power from the VRC2000, disconnect all status and metering-channel inputs, then disconnect and reconnect the internal lithium battery. After you reinitializing the VRC2000, all functions will return to their default status.

Before making final connections to site equipment, verify all VRC2000 programming. Check the words programmed into status, metering, and command-channel identifiers by accessing each channel. Status channels should all report the *open* state, since no closures have been connected to the unit yet. Connect a calibrated DC voltage to the metering-channel inputs to verify that proper programming of calibration constants and unit identifiers for each metering channel. Use a logic probe or voltmeter to verify the correct operation of each command channel.

VRC2000
Installation 

Before installing the VRC2000, be sure you have read and understood all sections of VRC2000 Setup (Pages 10–67). With proper planning, all set-up parameters can easily be configured in the VRC2000 prior to physical installation of the unit with any site equipment. If the set-up process is already complete, installation is reduced to a matter of connecting the wires.

SURGE PROTECTION NOTE:

The VRC2000 is a sensitive electronic device. In order to avoid damage to your unit, always properly protect the VRC2000 from voltage surges over connected telephone lines and AC power lines.

The VRC2000 is equipped with a highly reliable Telephone Surge Protector on the telephone-line input. Gentner Communications does not guarantee that this Telephone Surge Protector will protect the VRC2000 from damage caused by all voltage surges; however, the Telephone Surge Protector will limit such damage. *Never disconnect or bypass the Telephone Surge Protector.*

Step 1 — Determine Metering Channel Input Type

As shipped from the factory, the VRC2000’s metering-channel inputs are ready to read *voltage values* with an absolute maximum range of -5–10Vdc. However, should your application require that *current values* be monitored, the metering-channel inputs can be easily switched to reading an absolute maximum maximum range of -5–10mA.

If your application requires only voltage values to be monitored, skip to Step 2 — Metering Connections (next page). If your application requires current values to be monitored, continue with Step 1.

To change the metering-channel inputs to read current, place a Berg shorting jumper (provided) across the dual row post of the desired metering channels.

Figure 13 (See below.) will in determining the proper position for the Berg shorting jumper to change the metering channel from a voltage sensitive input to a current sensitive input.

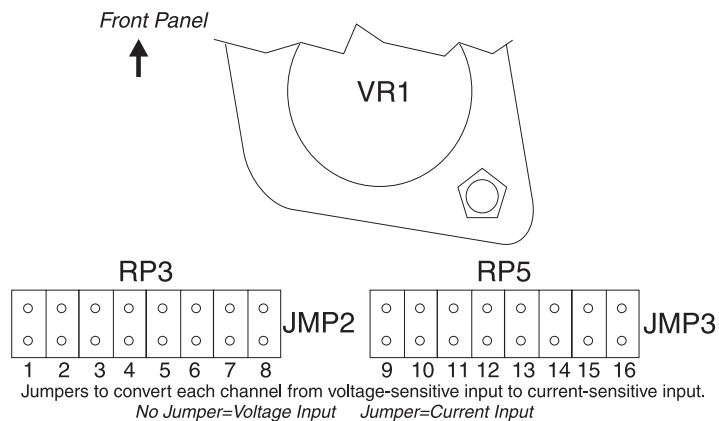

Figure 13. VRC2000 metering-channel input conversion

Once all metering-channel inputs requiring modification have been jumpered, continue to Step 2.

Step 2 — Metering Connections

The VRC2000's 16 metering-channel inputs are arranged together in the DB37 connector [7] labeled METERING on the unit's rear panel (Figure 14, below). For electrical specifications, see Specifications (Page 90). For pinouts, see Appendix B: Connector Pinouts (Page 98).

Figure 14. VRC2000 back-panel connectors

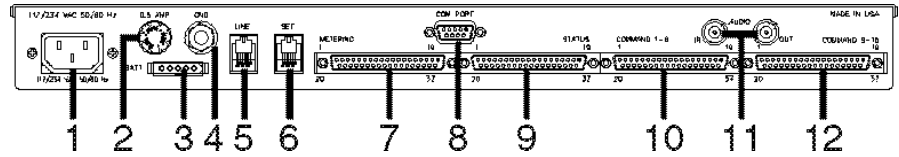

Each metering channel has two programmable upper tolerance limits, and two programmable lower tolerance limits. Each metering channel can also be calibrated in a linear numeric value proportional to input, or a power-to-linear input conversion. Metering channels can also be programmed to read indirect power (the multiplication of two consecutive channels, with the result appearing in the third channel as a new calibrated value).

Figure 15 (See below.) represents a single VRC2000 metering-channel input. Each metering-channel input is unbalanced, and is referenced to chassis ground.

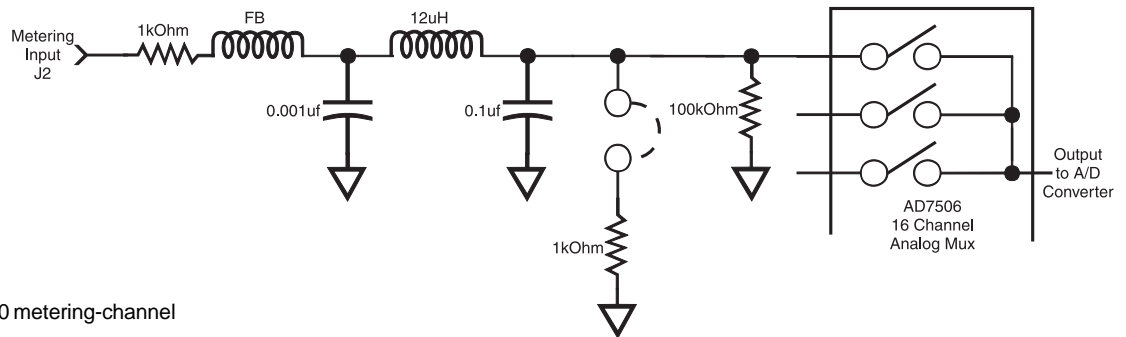

Figure 15. VRC2000 metering-channel input schematic

Connect the VRC2000 METERING connector to desired site equipment, remembering that input levels for metering channels *must not* exceed -5–10Vdc (voltage reading) or -5–10mA (current reading).

Step 3 — Determine Status-Channel Input Range

When the VRC2000 takes status readings, the voltage sample is broken down into two categories, logic 1 (open) or logic 2 (closed). How the readings is broken down is determined by the sample itself:

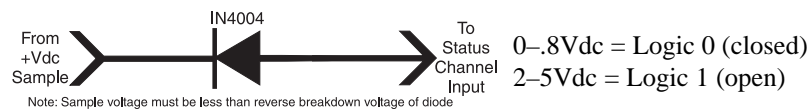

Figure 16. VRC2000 status-channel input with series diode inserted

Higher DC voltage levels can be connected to a status-channel input if a series diode is inserted to make the *open* range float (Figure 16, left).

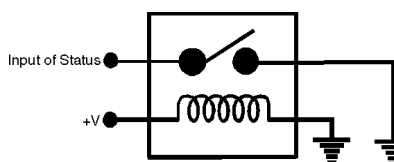

Figure 17. Status-channel surge protection

To protect the status channel from power surges, connect a relay to the input and ground (Figure 17, left). When the relay closes, input goes *low*.

VRC2000 Installation
Continued 

If your application does not require higher voltage capabilities, skip to Step 4 — Status Connections (below). If your applications does require higher input values, insert the series diode as indicated in Figure 16 (previous page).

Step 4 — Status Connections

The VRC2000's 16 status-channel inputs appear together in the DB37 connector on the rear panel labeled STATUS [9] (Figure 18, below). For electrical specifications, see Specifications (Page 90). For Pinouts see Appendix C: Connector Pinouts (Page 98).

Figure 18. VRC2000 back-panel connectors

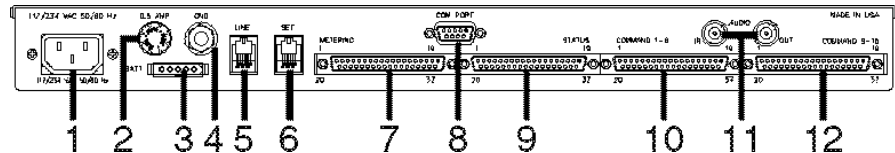

The electrical diagram in Figure 19 (See below.) represents a single VRC2000 status-channel input. Each such input is unbalanced, and is referenced to chassis ground.

Figure 19. VRC2000 status-channel input schematic

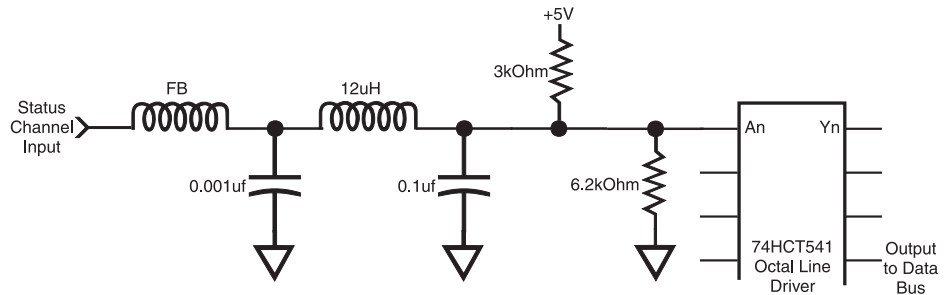

Connect the VRC2000 STATUS connector to desired site equipment, remembering that input levels for status channels *must not* exceed $-2-5.2\text{Vdc}$.

Step 5 — Command Connections

The VRC2000's 32 command-channel outputs are broken out into two DB37 connectors [10, 12] (See Figure 18, above.) to accommodate the 16 command channels, each with two output switches (A and B). The DB37 connectors are labeled COMMAND 1-8 and COMMAND 9-16. For electrical specifications, see Specifications (Page 90). For pinouts, see Appendix B: Connector Pinouts (Page 98).

Figure 20 (next page, top) shows a single VRC2000 command-channel output.

Connect the COMMAND 1-8 and COMMAND 9-16 connectors to desired site equipment, remembering that command channels must not exceed voltage of 48Vdc or sinking current of 250mA.

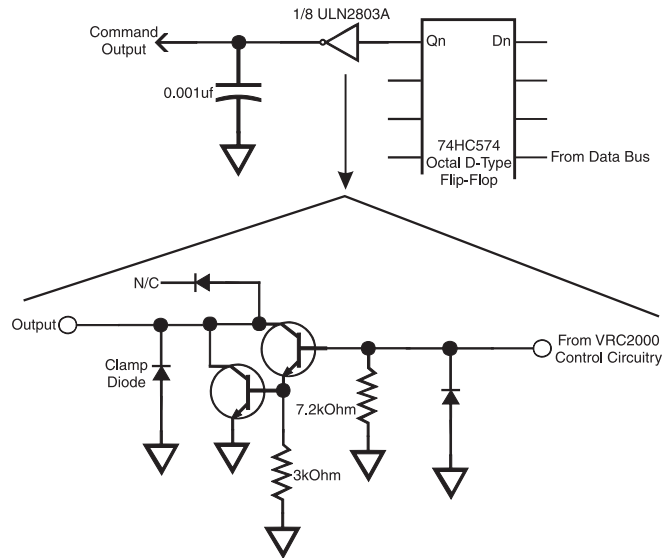

Figure 20 VRC2000 command-channel input schematic

Command Relay Unit

Figure 21 (below) provides examples of how to interface command-channel outputs to a Command Relay Unit.

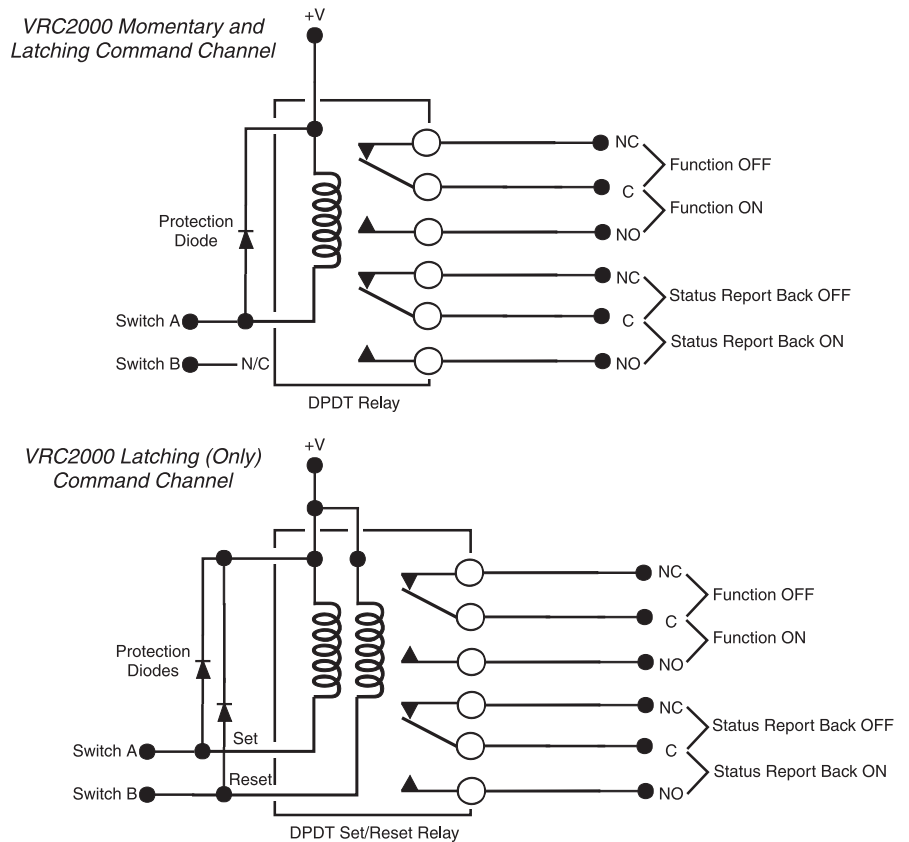



Figure 21. VRC2000-to-Command Relay Unit electrical schematic

For information about the Command Relay Unit, see Appendix C: Accessories (Page 100).

VRC2000 Installation
Continued **Step 6 — Telephone Interface Connection**

The VRC2000 was designed to be remotely operated using standard dial-up telephone lines. To accommodate this, the rear panel of the unit contains two modular telephone jacks (Figure 22, below).

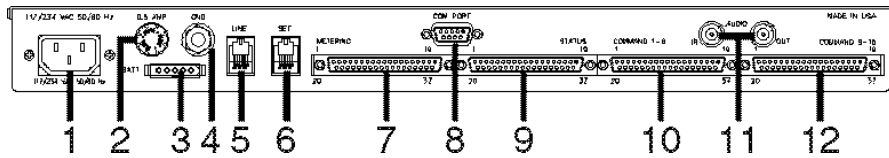

Figure 22. VRC2000 back-panel connectors

Connect the LINE jack [5] to a standard dial-up telephone line. Plug any DTMF telephone into the SET jack [6].

SURGE PROTECTION NOTE:

The VRC2000 is a sensitive electronic device. In order to avoid damage to the unit, always properly protect the VRC2000 from voltage surges over the telephone phone lines and connected AC power lines.

The VRC2000 is equipped with a highly reliable Telephone Surge Protector on the telephone LINE input. Gentner Communications does not guarantee that this Telephone Surge Protector will protect your unit from damage caused by all voltage surges; however, the Telephone Surge Protector will help *limit* such damage. *Never disconnect or bypass the VRC Surge Protector.*

The VRC2000 is registered with the Federal Communications Commission (FCC). Its use is governed by FCC Rules and Regulations Part 68, regarding devices to be connected to the switched telephone network.

The FCC places the following restrictions on the use of the VRC2000:

1. The VRC2000 cannot be connected to a party line or a pay telephone.
2. You must notify your local telephone company that the VRC2000, an automatic dialing device, is being installed. If the unit is permanently removed, you must again notify your local telephone company.
3. Gentner Communications Corporation must make all necessary repairs to the VRC2000 needed to maintain a valid FCC registration.

Your local telephone company has the right to disconnect service if problems develop on the telephone circuit in use by the VRC2000. The telephone company must provide proper notifications so the cause of such a problem can be addressed. Your local telephone company also has the right to make changes in their off-premises wiring. If any such changes are related to the VRC2000, the telephone company must notify you in writing of the changes so steps can be taken to maintain uninterrupted service.

Step 7 — Four-Wire Connections (Dedicated Circuits)

A dedicated circuit can be connected to the VRC2000, eliminating the need for a standard telephone line. With this four-wire connection, all VRC2000 functions can be accessed (required tones required to program the unit may be sent over the hard-wired audio circuit).

If your application does not require four-wire connection, skip to Step 8 —

Two-Way Radio Connection (below). If your application would benefit from four-wire connection, follow the step-by-step instructions below.

Dedicated four-wire circuits are available through two BNC connectors on the rear panel of the VRC2000, labeled AUDIO IN and AUDIO OUT [11]. For electrical specifications, see Specifications (Page 90).

The VRC2000 can be set up to *always* be online by programming the ring count to be zero. In the dedicated mode, send tones to the VRC2000 through the AUDIO IN port, and listen for responses through the AUDIO OUT port. The AUDIO OUT port can also be connected to an audio amplifier for easy monitoring of VRC2000 reporting.

Step 8 — Two-Way Radio Connection

A two-way radio system can be connected to the VRC2000, eliminating the need for any standard telephone line. All VRC2000 functions can be accessed with a two-way radio. In other words, the VRC2000 will perform the same functions over a two-way radio link as it will over a standard dial-up telephone line.

If, however, your application does not require two-wire radio connection, installation is complete; continue to Operation (next page). If your application does require two-wire radio connection, follow the instructions below.

At your remote site, connect your two-way radio receiver to the VRC2000 using the two BNC connectors on the VRC2000 rear panel, labeled AUDIO IN and AUDIO OUT [11].

Connect audio to be decoded by the VRC2000 to the AUDIO IN connector. Connect audio to be sent to the control site to the AUDIO OUT connector. For electrical specifications, see Specifications (Page 90).

A Push-To-Talk (PTT) output appears on pin 19 of both command-channel output connectors [10, 12] on the VRC2000's rear panel. These outputs are active low whenever the VRC2000 has data in its voice buffer (when the unit has information to report) or when the Data Interface is activated.

AUXILIARY AUDIO CONNECTION NOTE:

It is possible to use the auxiliary audio connections on the rear panel of the VRC2000 and the unit's built-in telephone coupler at the same time. However, the VRC2000 cannot assign a priority to either connection. In the case of two simultaneous incoming signals, the unit will be unable to decode the DTMF tones coming in over either connection.

At the control site, a DTMF generator must be supplied and properly connected to the two-way radio transmitter. Use a standard telephone instrument, a modem or other type of auto-dialer.

The VRC2000 will automatically come online when it receives the engineering DTMF tones "A B", in that sequence or "* #".

DTMF GENERATOR NOTE:

The DTMF generator you supply must be capable of producing the "A B C D" series of engineering tones in order to properly use the VRC2000 over a two-way radio connection.

VRC2000 Installation
Continued 

Entering the “C” engineering DTMF tone produces the same result as entering a “*”. Entering the “D” engineering DTMF tone produces the same result as entering a “#”.

CONTROL LOOP NOTE:

If the control loop is a two-wire circuit, use a telephone hybrid to convert this circuit into the required four-wire circuit. The TC100 Telephone Coupler incorporates several very useful features for such applications, including the capability to simulate a telephone loop.

In order to operate your VRC2000 over the two-way radio link, the dial-tone wait function and inactivity-timer function *must* be disabled.

Installation is now complete.

Operation 

DTMF tones operate the VRC2000, just as they were used to set it up. Using any DTMF telephone, the VRC2000 can be called to request readings on status and metering channels, issue commands to any of the command channels, check to see if there are any pending alarms, and/or clear the alarms.

Once the VRC2000 is set up, it is simple to operate the system.

Accessing User Mode

The VRC2000 has two modes of operation: user mode and setup mode. To gain access to user mode, enter the appropriate access code. (For information regarding access codes, see [Security, Page 11.](#))

There are two security levels that allow access to user mode: operator and user. *Operator* is the first level of security. With the operator access code, only readings from the status and metering channels can be taken. *User* is the second security level. With the user access code, readings can be taken from status and metering channels, and commands can be issued to any of the command channels.

Taking Readings From Status and Metering Channels

The following steps are required to request readings from the VRC2000’s status and metering channels.

Step 1 — Call the VRC2000

Dial the VRC2000’s telephone number. The VRC2000 will answer after the programmed number of rings, and give its programmed system-identifier phrase.

Step 2 — Enter Access Code

Enter the five-digit operator or user access code (as programmed into the VRC2000).

ACCESS CODE NOTE:

The VRC2000 will allow you to enter the code only once. If a mistake is made, the VRC2000 will automatically hang up.

The VRC2000 will immediately report whether or not any alarms are pending. If alarms are pending, the unit will say

- ALARMS PENDING

If there are no alarms, it will say

- NO ALARMS PENDING

Step 3 — Request Status Reading

Enter the following code in order to request a reading from a status channel:

☛ “7 x x *”

x x NOTE:

Substitute the appropriate code for the x x that corresponds with the channel number to be accessed (i.e. 01 is channel 1, 11 is channel 11).

The VRC2000 will respond with the phrase set up for the status channel, followed by the phrase set up for the actual current state of the status channel.

Step 4 — Request Meter Reading

Enter the following code in order to request information about a metering channel:

☛ “6 x x *”

The VRC2000 will respond with the phrase set up for the metering channel, followed by the phrase set up for the actual current reading of the metering channel.

Step 5 — Sign Off

Sign off from the VRC2000 by entering the following code:

☛ “9 9 9”

The VRC2000 will respond:

- GOOD-BYE

Then the unit will automatically hang up the telephone line.

HANG-UP NOTE:

The VRC2000 will also automatically hang up if no codes are entered for a period of five minutes (if the inactivity timer is enabled).

Single/Multiple Responses From Status/Metering Channels

Either single or multiple responses can be requested from status and metering channels.

Single Response

A single response is requested by entering “*” after the status or metering-channel code. This instructs the VRC2000 to send only a single response to your request, which will be *accurate as of the exact time the “*” was entered.*

Multiple Response

A multiple response is requested by entering “#” after the status or metering-

Operation
Continued 

channel code. This instructs the VRC2000 to give six consecutive responses (at eight-second intervals), for the metering or status channel. Each response will be *accurate as of the time of the response*. Multiple responses allow changes in status or metering-channel inputs to be tracked over a short period of 40 seconds.

To stop a multiple response before it completes all five responses, enter the same access code again for the particular status or metering channel, followed by “*”.

Issuing Commands

To issue commands to a command channel (as well as request readings from the status and/or metering channels), follow these steps:

Step 1 — Call the VRC2000

Dial the VRC2000’s telephone number.

The VRC2000 will answer after the programmed number of rings, and state the system-identifier phrase as programmed.

Step 2 — Enter Access Code

Enter the five-digit user access code programmed into the VRC2000.

ACCESS CODE NOTE:

The VRC2000 will allow you to enter the code only once. If a mistake is made, the VRC2000 will automatically hang up.

The VRC2000 will immediately report whether or not any alarms are pending. If alarms are pending, the unit will say

- ALARMS PENDING

If there are no alarms, it will say

- NO ALARMS PENDING

OPERATOR ACCESS CODE NOTE:

The operator access code will not allow commands to be manually issued.

Step 3 — Request Status Reading

Enter the following code in order to request a reading from a status channel:

 “7 x x *”

x x NOTE:

Substitute the appropriate code for the x x that corresponds with the channel number to be accessed (i.e. 01 is channel 1, 11 is channel 11).

The VRC2000 will respond with the phrase set up for the status channel, followed by the phrase set up for the actual current state of the status channel.

Step 4 — Request Meter Reading

Enter the following code in order to request information about a metering channel:

◆ “6 x x *”

The VRC2000 will respond with the phrase set up for the metering channel, followed by the phrase set up for the actual current reading of the metering channel.

Step 5 — Access Command Channel

Access the command channel by entering the following code:

◆ “2 x x”

The VRC2000 will respond with the programmed identifying the command channel.

Step 6 — Energize Switch (A or B)

Enter the following code to energize *switch A*:

◆ “*”

The VRC2000 will respond with the programmed phrase identifying switch A, and energize the selected command channel’s switch A.

OR

Enter the following code to energize *switch B*:

◆ “#”

The VRC2000 will respond with the programmed phrase identifying switch B, and energize the selected command channel’s switch B.

Each switch is activated immediately after entering “*” or “#”. Either symbol can be entered several times in a row (if desired).

Multiple A/B Switch Example. Entering the following sequence

◆ “2 0 1 * # * #”

would first activate command channel 1’s A switch, then the B switch, then the A switch again, then the B switch again.

Using the default command channel feature, a command-channel switch can be immediately activated after requesting a reading from any status or metering channel.

Default Command Channel Example. Immediately after the VRC2000 has reported the current reading for a particular status or metering channel, enter a “*” to activate the command channel’s A switch programmed as the default command channel; enter a “#” to activate the command channel’s B switch programmed as the default command channel for that specific status/ metering channel.

Say command channel 10 was set up to control perimeter lights at a remote site, and status channel 8 was programmed to monitor the status of those lights. If command channel 10 was also programmed as the manual command assignment for status channel 8, an additional “*” can be entered

Operation
Continued 



Figure 23. DTMF keypad

to activate command channel 10's A switch (or an additional “#” can be entered to activate command channel 10's B switch) after accessing status channel 8 with the “7 0 8 *”.

Step 7 — Sign Off

Sign off from the VRC2000 by entering the following code:

☎ “9 9 9”

The VRC2000 will respond:

- GOOD-BYE

Then the unit will automatically hang up the telephone line.

HANG-UP NOTE:

The VRC2000 will also automatically hang up if no codes are entered for a period of five minutes (if the inactivity timer is enabled).

Remembering VRC2000 Codes

The codes for status, metering, and command channels correspond to the letters that are etched into the number keys of a standard DTMF telephone (Figure 23, left).

Thus, command corresponds with 2, metering corresponds with 6, and status corresponds with 7.

Alarms

The VRC2000 saves the most recent 32 alarms and reports them to you. Alarms can be cleared at any time and, of course, commands can be issued to the VRC2000 to correct the condition which caused the alarm. There are four types of alarms: unauthorized access, status channel, metering channel and metering-system failure.

Unauthorized Access

An alarm condition will be activated by three attempted unauthorized accesses. In other words, if anyone attempts to enter an incorrect access code three time in a row, the VRC2000 will report that an unauthorized person is attempting to gain access to the site. If such an alarm occurs, Gentner Communications recommends changing access codes as a safety measure.

Status Channel

Each status channel can be programmed to cause an alarm condition when it changes its state.

Metering Channel

Each metering channel can trigger an alarm from any one of four tolerance limits.

Metering-System Failure

A metering-system failure alarm will be generated if any status or metering-channel input is overloaded.

Muting Outbound Telephone Numbers

The VRC2000 can be prevented from calling outbound telephone numbers for a period of one hour by entering the following code:

☛ “0 3 0 *”

The VRC2000 will respond:

- PLEASE ENTER SYSTEM ACCESS CODE

Now enter the correct seven-digit system access code. After the correct system access code is entered, the VRC2000 will respond:

- ALARM REPORTING DISABLED

This disables alarm reporting for one hour. This is useful when reprogramming the unit, or making changes to connected site equipment.

Sample Scenario

Maintenance needs to be performed on the transmitter. Naturally, the best time for the transmitter to be down is around 2 a.m. Just shutting down the transmitter will generate alarms, calling a supervisor at 2 a.m. or calling the station engineer who is performing the maintenance (and already *knows* the transmitter is down). Thus, the station engineer could shut down the transmitter for a one-hour period to perform the maintenance and, with the alarms disabled, the system would not call the outbound telephone numbers to report them. If maintenance is finished prior to the one-hour period, the alarm reporting can be enabled manually (below).

To enable alarm reporting before the end of the one-hour period, enter

☛ “0 3 0 #”

The VRC2000 will respond:

- ALARM REPORTING ENABLED

To determine what alarms are present, enter the following code:

☛ “0 0 0”

If no alarms are present, the VRC2000 will respond:

- NO ALARMS PENDING

If alarms *are* present, the VRC2000 will list causes of the alarm conditions, beginning with the oldest alarm stored in the system. After each alarm is reported, they can either be cleared or the alarm-reporting routine can be immediately exited.

ALARM NOTE:

Clearing an alarm does not mean that the condition that caused the alarm has been corrected.

To exit the alarm reporting routine, enter “*”.

Operation
Continued 

Once the cause of an alarm is determined, the problem can be corrected by issuing commands to the appropriate command channels.

To clear all alarms stored in the VRC2000 by entering

☛ “0 1 0”

This clears all alarms. Be careful with this command, since alarms *cannot* be recalled once they have been cleared.

If a “*” is entered during alarm reporting, the VRC2000 will stop reporting alarms, return to normal operation and wait for a command.

Status-Channel Alarms

Status-channel alarms are generated when the sample changes its state (i.e. a status channel sample goes low or high). For example, if an alarm is generated and cleared, a new alarm will *not* be generated until the status channel goes high and then goes low again, even though the status channel’s sample remains in the low condition. The alarm is generated by the *transition* between the high and low states.

Metering-Channel Alarms

Metering-channel alarms are generated the same way as status-channel alarms. The first high limit for a metering channel could be set to generate an alarm. If an alarm is generated and cleared, a new alarm will *not* be generated until the metering-channels sample returns to the metering channel’s nominal range and then rises to above the first high limit. Once again, the alarm is generated by the *transition* over the tolerance limit.

Checking Current Date and Time

To check the VRC2000’s real-time clock, enter

☛ “0 6 0”

The unit will respond with the current date and time.

Using Sequence Output Programs

To use the first sequence-output program, enter the following code:

☛ “5 0 1 #”

Your VRC2000 will respond:

- SEQUENCE ONE ENABLED

The VRC2000 will continue with all information configured into the sequence-output program. There are four sequence-output programs available on the VRC2000. To access them, use the codes in Table 14 ([next page, top](#)).

Table 14. Sequence Output Access Codes

<u>You Enter</u>	<u>To Access Sequence Output Program</u>
☎ "5 0 1 #"	Sequence 1
☎ "5 0 2 #"	Sequence 2
☎ "5 0 3 #"	Sequence 3
☎ "5 0 4 #"	Sequence 4

Any sequence-output program can be halted at *any time* while the VRC2000 provides the programmed information by entering *any* DTMF digit.

Using the Sound Sensor

The VRC2000 unit contains a small condenser microphone built into its front panel. This microphone can be activated, at any time, to listen to any sounds being generated in the vicinity of the VRC2000. This is handy to check for proper operation of cooling fans or other noisy equipment, or even listening for other people's voices in the area of your VRC2000 (in the case of a security alarm).

To activate the sound sensor, enter

☎ "0 5 0 #"

This will activate the sound sensor for 30 seconds.

To deactivate the sound sensor at any time prior to the end of the 30 seconds, enter

☎ "0 5 0 *"

Turning the Data Interface ON/OFF

If your VRC2000 is equipped with the Data Interface, it can be activated/deactivated while you are in operator or user mode.

To turn the Data Interface ON, enter

☎ "0 2 0 #"

The VRC2000 will emit a high-pitched electronic (modem) tone. This is the sound of the electronic data format that the Data Interface uses to transmit information about the VRC2000 to the PC equipped with a modem.

"0 2 0 #" CODE NOTE:

Do not use the "0 2 0 #" code if your VRC2000 is not equipped with the Data Interface.

To turn the Data Interface OFF, enter

☎ "0 2 0 *"

The high-pitched electronic tone will stop, and the VRC2000 will say

• VOICE SELECTED

Operation
Continued 

DATA INTERFACE DEACTIVATION NOTE:

*It is not always possible to turn the Data Interface OFF with the “0 2 0 *” code. The noise created by the Data Interface will sometimes prevent the unit from properly decoding the command. However, the Data Interface will automatically turn itself OFF after 45 seconds if it has not established a modem connection.*

Refer to the Data Interface Installation and Operations Manual, Setup VRC2000 Installation and Operations Manual, and/or VRC-Win Installation and Operations Manual for information on how to install and use the Data Interface.

Auto-Logging

If your VRC2000 is equipped with the Data Interface, the system can be configured to automatically dial an outbound telephone number (or key on a two-way radio system’s PTT switch), turn on the Data Interface, and transmit all metering and status-channel readings to a PC running Setup VRC2000 software in terminal mode or VRC-Win software. The system can be programmed to auto-log at regular intervals. These intervals can be as short as 15 minutes, or as long as 11 hours and 59 minutes.

Refer to the Data Interface Installation and Operations Manual, Setup VRC2000 Installation and Operations Manual, and/or VRC-Win Installation and Operations Manual for more information about auto-logging.

Auto-logging can *only* be enabled/disabled in the set-up mode.

DATA INTERFACE NOTE:

A Data Interface must be installed in the VRC2000 to use auto-logging.

The VRC2000 is a highly specialized device. Repair and maintenance should always be done by fully qualified service technicians.

CIRCUIT NOTE:

The VRC2000 contains CMOS integrated circuits. Any internal service should only be attempted in a static-free environment.

General Treatment

The VRC2000 is designed to operate in conditions typical of transmitter/remote sites. The unit should be kept clean and dry to prevent damage. When transporting the VRC2000, Gentner Communications recommends using a static-free case or bag.

Troubleshooting

This section provides details in locating minor problems with a VRC2000. The following measurements can help diagnose problems. Please read the warranty in Section Two of this manual before attempting to field service a VRC2000.

• Power Supply

Typical Readings

J7 Pin 1 = 10Vdc	Digital Regulator Input
J7 Pin 3 = 20Vdc	Positive Analog Regulator Input
J7 Pin 4 = -20Vdc	Negative Analog Regulator Input

U23 Pin 40 = 4.8–5.2Vdc	Digital Supply
U32 Pin 1 = 11.7–12.3Vdc	Positive Analog Supply
U46 Pin 4 = -11.7–-12.3Vdc	Negative Analog Supply

Battery OFF position = 3.6VdcRAM, Clock Backup

Repair Procedure (If Necessary)

Power-supply problems are typically incorrectly determined to be faulty regulators. The actual cause of most power-supply problem is a bad integrated circuit, which causes the regulator(s) to dissipate an abnormal amount of power, or even shut down.

The digital supply-to-circuit ground continuity is from 200–300 Ohms. A readings lower than 200 Ohms (with the power OFF), indicates an integrated-circuit failure.

Metering-System Failure Alarms. Metering-system failure system alarms can be generated by dirty AC power. Verify that the AC ripple on the analog supplies is less than 30mV if the VRC2000 reports these alarms.

• Processor Preset

Typical Readings

U23 Pin 1 = 5Vdc

Repair Procedure (If Necessary)

Check the reset circuitry. The VRC2000 automatically holds its processor in reset if the AC line input drops below 72Vac RMS.

• **Processor Constantly Interrupted**

Typical Readings

U23 Pin 2 Constantly clocked.

Repair Procedure (If Necessary)

Interrupt problems occur only when the VRC2000 hardware is damaged. A good place to check for this damage is the microprocessor address/data bus. The resistance between each of U23 pins 21–28 and ground should be 10kOhms. If any of these pins measures differently, it indicates that a port on the bus has broken down. Contact Gentner Communications technical support.

• **Poor or No DTMF Decoding**

Typical Readings

U55 Pin 3 = 3.576–3.583MHz Clock

U16 Pin 8 < 1.5V peak-to-peak when receiving DTMF tones.

Repair Procedure (If Necessary)

Since DTMF receive levels vary from area to area, it may be necessary to adjust the gain in the DTMF receive amplifier. The circuit in Figure 24 (below) depicts the receive amplifier.

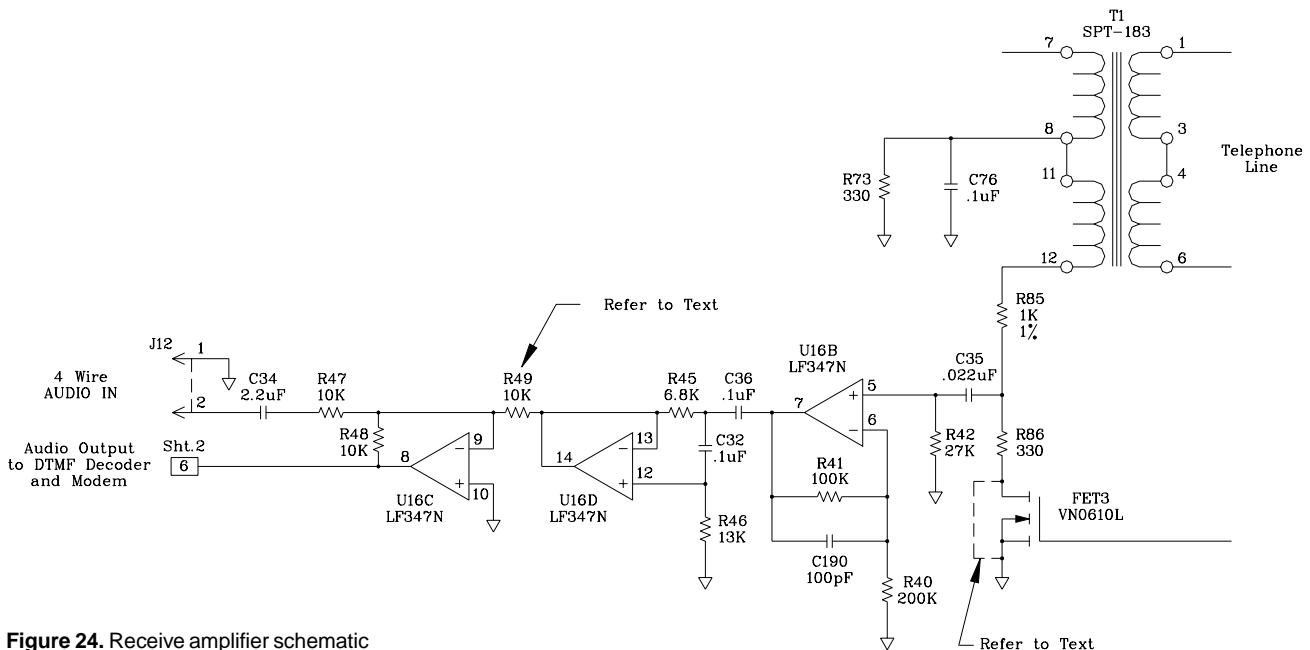

Figure 24. Receive amplifier schematic

The analog input of the SSI202 DTMF decoder has a 40dB window of acceptable DTMF level. As shipped from the factory, that window is centered at -20dBm, setting the maximum acceptable, nominal input level 0dBm, and the minimum -40dBm. This nominal level (-20dBm) is typically 1.5V p-p at pin 8 of U16C. If a VRC2000 has a DTMF level greater than this at U16C’s output, then either of the following simple changes can be made to adjust the receive window.

Suggestion 1: Connect the junction of R86 and FET3’s drain to ground by shorting across FET3’s drain and source leads.

Suggestion 2: Increase the value of R49.

If R49 is changed to 20kOhms, 6dB of attenuation is obtained. It may be

necessary to raise R49 to 100kOhms if DTMF receive levels approach 2V peak-to-peak. If a VRC2000 has a low DTMF receive level, the voltage gain of U16B can be increased by decreasing the value of R49.

• **RFI Interference (Poor DTMF Decoding No Auto-Answer)**

Typical Reading/Finding

U42 Pin 5 Pulses low during ring.

Ringing voltage must be 30–120VRMS, 15–80Hz RFI audio on phone line.

Repair Procedure (If Necessary)

RFI problems are cured with any or a combination of the following methods:

Suggestion 1: Correct site grounding problems.

Suggestion 2: Update the phone company’s surge protection.

Suggestion 3: Build a filter.

Suggestion 4: Buy a filter.

The VRC2000 should be grounded using common RF-protection practices. Avoid wiring that creates ground loops (two different paths to station ground).

AM RFI is often generated by central office carbon-shunt surge protections installed from tip and ring to ground. Update this protection to gas tubes.

AM and FM RFI can be trapped using a filter. Figure 25 (below) illustrates suggested RFI filters.

Component Values			
		Disc Caps. Rated $\geq 100V$	
AM	L 22uH	Ca 0.0022uF	Cb 1,000pF
FM	390–500uH	220pF	100pF

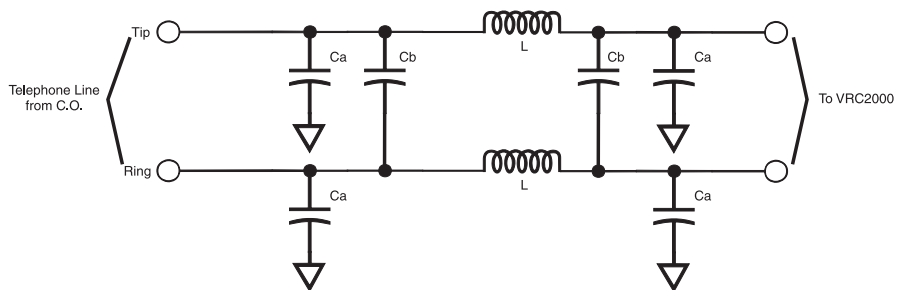

Figure 25. RFI filter.

The telephone company can provide filters. VRC2000’s installed at AM sites have performed well with AT&T’s Z100A filter.

• **Metering System Failure Alarms**

Typical Readings

J1 Pins 1–16 less than 10Vdc

Analog Regulator AC ripple less than 30mV peak to peak.

Repair Procedure (If Necessary)

The VRC2000 can only monitor DC potentials up to 10Vdc or 10mA.

The VRC2000 will report metering-system failure alarms if an instantaneous reading is taken above these limits.

Poor power rectification can only be cleaned up by AC line conditioning.

Maintenance/Service
Continued 

• **Condenser Problems**

The VRC2000's built-in condenser microphone is very sensitive. If the VRC2000 is to operate in a noisy environment, a gain adjustment in the condenser-microphone circuit may be necessary.

Attenuation of 24dB in the microphone's output can be obtained by opening R35 to make U15C a voltage follower. Further changes in the microphone level can be made by varying R31 and R30 in the next stage of amplification, U15B. VRC2000 users may opt to connect other audio sources to this input.

The circuit presented in Figure 26 (below) depicts the amplifier used to boost the microphones level.

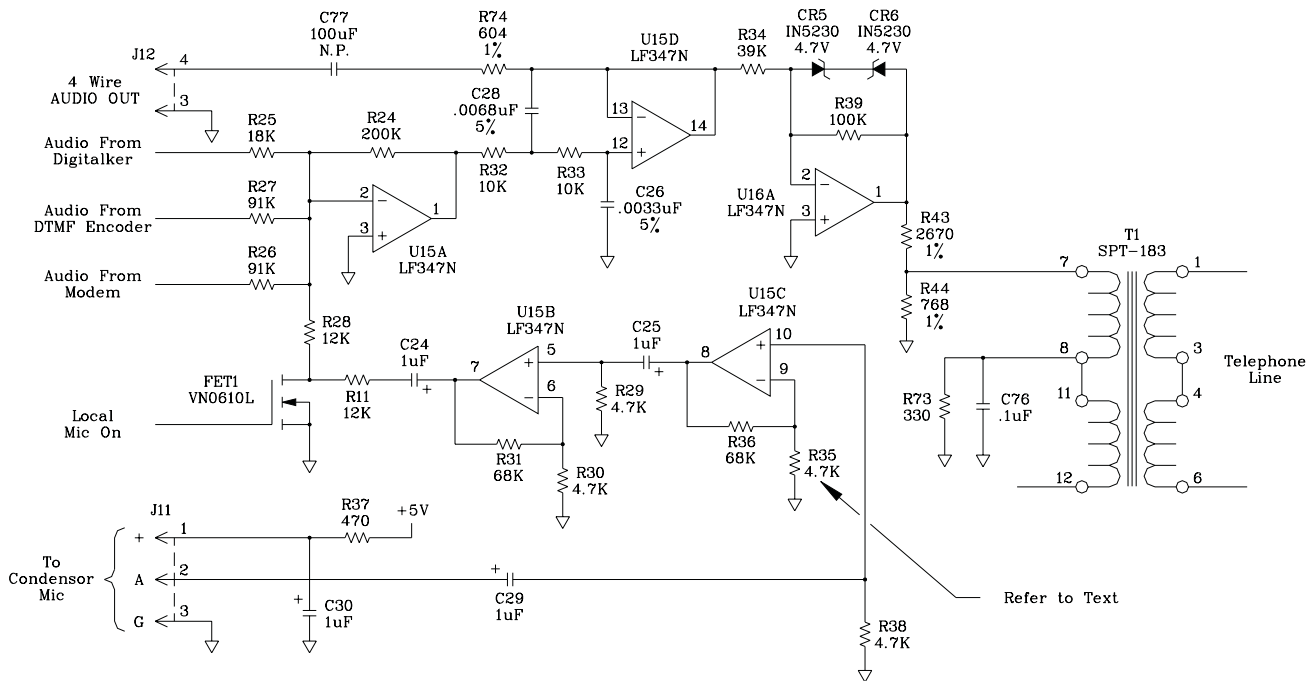

Figure 26. Microphone amplifier schematic

Frequently Asked Questions **Question**

Is there any way to speed up VRC2000 setup?

Answer

Yes. VRC2000 setup can be sped up in several ways:

- Use VRC-Win Software (Windows®)
- Use Setup VRC2000 Software (DOS)
- Use the “9 3 0” Voice Off instruction
- Use a speed dialer
- Force an [ERROR] after desired set-up feature has been updated
- Tape record the required set-up DTMF tones required, then play them back to the unit.

Question

Can I enter set-up mode from the remote site or take readings from local mode?

Answer

Yes. The DTMF tones “9 2 0” toggle the VRC2000 from local set-up mode to local-user mode for taking readings. The DTMF tones “9 1 0” toggle the unit from remote-user mode to remote set-up mode.

Question

What do I do if I forget the system-access code or accidentally change it?

Answer

The *only* way to restore control is to erase *all* VRC2000 programming by removing the Berg jumper from the internal-lithium battery, then reprogramming your unit. Be sure to remove AC power from the unit, and disconnect all metering and status-channel inputs before reconnecting the internal-lithium battery.

Question

Why does my VRC2000 issue metering-system failure alarms?

Answer

Typically, this is caused by metering inputs with instantaneous voltages greater than 10Vdc or severe fluctuations in the AC line supplying the unit. However, damaged or faulty metering-circuit components can cause these alarms.

Question

Why does my VRC2000 continually report alarms on a single metering channel?

Answer

This typically indicates that the tolerance limits for that metering channel are improperly set (too tight).

Question

My VRC2000 doesn't save the set-up features I program when the unit loses power. What's happening?

Answer

Either the Berg jumper on the internal-lithium battery is in the OFF position, the battery has discharged all of its power, or the battery has been damaged. The internal-lithium battery has a life expectancy of four years.

Frequent Questions
Continued 

Question

My VRC2000 won't automatically answer a ringing line. What can I do?

Answer

Try the following

- Set up the ring count for one ring.
- Verify that the circuit in use has a Class B ringer equivalency.
- RFI filter the telephone line.

Question

My VRC2000 won't respond to DTMF commands. What can I do?

Answer

Verify that this is true with a variety of telephone instruments, and from different telephone lines, then use the following list for suggestions.

- DTMF receive levels are distorted when issued after line connection on some telephone exchanges. Typically, lowering the VRC2000's receive window cures this problem.
- Your telephone line in use may have RFI problems. Use a RFI filter.

Question

How do I figure an accurate calibration constant if my operating level is 5,200V and my sample voltage is 4.5Vdc?

Answer

Set up the metering channel in use with a units identifier of KILO VOLTS, then the calibration constant would be $(5.2)/(4.5)$, which is 1.155.

Think of calibration constant in this manner:

“What number must I multiply my sample by to equal my actual representation?”

Question

How long should I keep a status channel input low to assure VRC2000 detection?

Answer

At least one second.

Question

I need to monitor status conditions with a logic high greater than 5.2V. What can I do?

Answer

Use a series diode to make the highs float which still allows the lows to conduct current and pull the status channel low.

Question

What benefits does the Data Interface accessory provide?

Answer

The Data Interface can provide real-time readouts of all VRC2000 inputs for display on a PC running Setup VRC2000 software (DOS) or VRC-Win software (Windows®). It also allows users to program time-based automatic logs for hard-copy storage or digital storage on your PC.

Question

What is the cost of the Setup VRC2000 software?

Answer

It's *free* for download from the Gentner Web Site. Connect to **http://www.gentner.com**, click the TECHNICAL SUPPORT button, access the SITE CONTROL page, then select Setup VRC2000 software download. This DOS-based software accelerates and simplifies VRC2000 setup for both the novice and advanced user. It also makes set-up changes extremely efficient.

Question

Is VRC-Win software worth the money?

Answer

Yes! All from within the point-and-click Windows® environment, VRC-Win software accelerates and simplifies VRC2000 setup with the power of graphic user interface, making set-up changes extremely efficient, and online monitoring intuitive. Contact your dealer for cost.

Question

What do I do if my VRC2000 requires factory service?

Answer

Gentner Communications must issue a *return authorization (RA) number* to the user before shipment of a unit is accepted. To obtain a RA number, call Gentner Communications Technical Support at one of the numbers listed at the bottom of the page. Gentner Communications maintains a stock of VRC2000 loaner units that are routinely provided to customers who need a remote control while their unit is away for repair.

NON-WARRANTY REPAIR NOTE:

VRC2000 non-warranty repairs can be costly. Protect your unit from electrical surges caused by lightning and other high-voltage transients. Always use telephone/AC surge protectors. Double check the unit's electrical specifications before making any input or output connections.

VRC2000

Dimensions

19"/48.3cmW x 1.75"/4.45cmH x 10"/25.4cmD

Weight

11 lbs/4.98 kg (dry)

16 lbs/7.26 kg (shipping)

Connectors

LINE: RJ11C modular phone jack; automatic answering ring voltage 30–120 VRMS, 15–68Hz; ring duration of 178 milliseconds minimum, with interval of 500 milliseconds to 10 seconds

SET: RJ11C modular phone jack

COMMAND 1–8: DB37; 32 outputs, configured in 16 channels of two commands each; open collector outputs rated at 48Vdc, sinking current 250mA; can be set up to function as latching or momentary

COMMAND 9–16: DB37; 32 outputs, configured in 16 channels of two commands each; open collector outputs rated at 48Vdc, sinking current 250mA; can be set up to function as latching or momentary

METERING: DB37; 16 metering channels with resolution of one in 1,024, with four-digit accuracy of +/- 0.5%; +/- 0.25V minimum for full scale, +/- 1V minimum recommended; -5–5V or 0 to 10Vdc maximum (selectable); maximum voltage allowed: -5–10Vdc; maximum current allowed: -5–10mA

STATUS: DB37; 16 TTL-compatible status channels with range of 0–0.8Vdc recognized as Logic 0 (closed); range of 2–5Vdc recognized as Logic 1 (open); maximum voltage allowed: 0.2–5.2Vdc.

AUDIO IN/OUT: Standard BNC connectors

Power Requirements

177Vac or 234Vac (manual switching required); 50–60Hz; 15W nominal

Operating Temperature

-20–70° C

Specifications are subject to change without notice.

Firmware License

The VRC2000 is a microprocessor-based system. All firmware for the unit was developed by Gentner Communications Corporation. Your new VRC2000 was shipped in a sealed static-protective bag with a label referring you to the conditions outlined in the firmware license agreement (below). When this seal is broken, the terms and conditions of this agreement become effective.

Gentner Firmware License Agreement

Gentner Communications Corporation (hereinafter referred to as Gentner) is the sole owner of the VRC2000 firmware. The VRC2000 firmware is defined as all software stored in the memory device supplied with this license. Gentner grants to the purchaser and/or the end-user of the VRC2000 Voice Remote Control a nonexclusive license to use the firmware under the following terms and conditions:

THIS FIRMWARE IS

- A. For use on only the VRC2000 which has been purchased and properly registered by serial number with Gentner.
- B. Not to be copied or duplicated in any way, and not to be transferred or delivered to any other person or entity without the written consent of Gentner.
- C. Protected by all applicable copyright and patent laws. The copyrights and patents assigned to Gentner for the VRC2000 remain the sole property of Gentner.

This license does not assign or transfer ownership of the firmware. Included in this license is all information contained in the instructional manuals, schematic diagrams and related materials.

This license shall remain in effect for the life of your VRC2000. You may terminate the license by returning the VRC2000 to Gentner in its original container, seal intact. This license is automatically terminated if you violate any of the terms and conditions of this license. Upon such termination, the VRC2000 must be returned to Gentner.

Cancellation or termination of this license agreement shall not result in the return or refund of funds if the seal on the original container has been broken or is not fully intact.

This license agreement is granted solely to the original purchaser of the VRC2000. If the VRC2000, and thus the firmware and this license, is to be passed to another person or entity in any way, the original purchaser must advise Gentner in writing of this transfer. The new holder of the VRC2000 must acknowledge in writing acceptance of the terms and conditions of this license. The license shall be deemed terminated if such written acceptance is not presented to Gentner.

Warranty

Gentner Communications Corporation (Manufacturer) warrants that this product is free of defects in both materials and workmanship. Should any part of this equipment be defective, the Manufacturer agrees, at its option, to:

A. Repair or replace any defective part free of charge (except transportation charges) for a period of one year from the date of the original purchase, provided the owner returns the equipment to the Manufacturer at the address set forth below. No charge will be made for parts of labor during this period;

B. Furnish replacement for any defective parts in the equipment for a period of one year from the date of original purchase. Replacement parts shall be furnished without charge, except labor and transportation.

This Warranty excludes assembled products not manufactured by the Manufacturer whether or not they are incorporated in a Manufacturer product or sold under a Manufacturer part or model number.

THIS WARRANTY IS VOID IF:

A. The equipment has been damaged by negligence, accident, act of God, or mishandling, or has not been operated in accordance with the procedures described in the operating and technical instructions; or,

B. The equipment has been altered or repaired by other than the Manufacturer or an authorized service representative of the Manufacturer; or,

C. Adaptations or accessories other than those manufactured or provided by the Manufacturer have been made or attached to the equipment which, in the determination of the Manufacturer, shall have affected the performance, safety or reliability of the equipment; or,

D. The equipments original serial number has been modified or removed.

NO OTHER WARRANTY, EXPRESS OR IMPLIED, INCLUDING WARRANTY OF MERCHANTABILITY OR FITNESS FOR ANY PARTICULAR USE, APPLIES TO THE EQUIPMENT, nor is any person or company authorized to assume any warranty for the Manufacturer or any other liability in connection with the sale of the Manufacturer's products.

Manufacturer does not assume any responsibility for consequential damages, expenses, or loss of revenue or property, inconvenience, or interruption in operation experienced by the customer due to a malfunction in the purchased equipment. No warranty service performed on any product shall extend the applicable warranty period.

In case of unsatisfactory operation, the purchaser shall promptly notify the Manufacturer at the address set forth below in writing, giving full particulars as to the defects or unsatisfactory operation. Upon receipt of such notice, the Manufacturer will give instructions respecting the shipment of the equipment, or such other matters as it elects to honor this warranty as above provided. This warranty does not cover damage to the equipment during shipping and the Manufacturer assumes no responsibility for such damage. All shipping costs shall be paid by the customer.

This warranty extends only to the original purchaser and is not assignable or transferable.

Gentner Communications Corporation, 1825 Research Way, Salt Lake City, Utah 84119

FCC Part 15 Compliance

This equipment has been tested and found to comply with the limits for a Class A digital device, pursuant to Part 15 of the FCC rules. These limits are designed to provide reasonable protection against harmful interference when the equipment is operated in a commercial environment. This equipment generates, uses, and can radiate radio frequency energy and, if not installed and used in accordance with the instruction manual, may cause harmful interference to radio communications. Operation of this equipment in a residential area is likely to cause harmful interference, in which case the user will be required to correct the interference at his/her own expense.

Changes or modifications not expressly approved by Gentner Communications Corporation could void the user's authority to operate the equipment.

*FCC Part 68
Compliance* 

**FCC Registration Number: FBI5FU-71578-MD-T
The Ringer Equivalence Number (REN) is 1.1B**

A label containing, among other information, the FCC registration number and Ringer Equivalence Number (REN) for this equipment is prominently posted on the top plate, near the rear of the equipment. If requested, this information must be provided to your telephone company.

USOC Jacks: This device uses RJ11C and RJ21X terminal jacks.

The REN is used to determine the quantity of devices which may be connected to the telephone line. Excessive RENs on the telephone line may result in the devices not ringing in response to an incoming call. In most, but not all areas, the sum of the RENs should not exceed five (5). To be certain of the number of devices that may be connected to the line, as determined by the total RENs, contact the telephone company to obtain the maximum RENs for the calling area.

If this equipment causes harm to the telephone network, the telephone company will notify you in advance that temporary discontinuance of service may be required. If advance notice is not practical, the telephone company will notify the customer as soon as possible. Also, you will be advised of your right to file a complaint with the FCC if you believe it is necessary.

The telephone company may make changes in its facilities, equipment, operations, or procedures that could affect the operation of the equipment. If this happens, the telephone company will provide advance notice for you to make the necessary modifications in order to maintain uninterrupted service.

If you experience problems with this equipment, contact Gentner Communications Corporation, 1825 Research Way, Salt Lake City, Utah 84119, or by phone at (801) 975-7200 for repair and warranty information. If the trouble is causing harm to the telephone network, the telephone company may request you remove the equipment from the network until the problem is resolved.

No user serviceable parts are contained in this product. If damage or malfunction occurs, contact Gentner Communications for instructions on its repair or return.

This equipment cannot be used on telephone company provided coin service. Connection to Party Line Service is subject to state tariffs.

*U.S. Patent
Information* 

The technology used in the VRC2000 is protected by U.S. Patent No. 4,872,195.

Appendix A: Glossary

Throughout this manual, you may notice some unfamiliar terms, or terms that may not necessarily apply to your application or industry. For purposes of simplification, broadcast industry terms will be used throughout this document. Some of these terms, and their counterpart meaning in other industries, appear below.

AC Current Sensor	Accessory allowing accurate measurement of current samples from AC power. See Appendix C: Accessories (Page 100).
Access Codes	The VRC2000 provides three security levels. Enter the correct access code to use the VRC2000 system in any of the three security levels.
Accessories	Gentner Communications provides both hardware and software accessories to meet VRC2000 needs. See Appendix C: Accessories (Page 100).
Alarm	The VRC2000 uses alarms to trigger certain actions. What triggers alarms and what happens when an alarm is triggered is determined by user programming. The VRC2000 stores the most recent 32 alarms in memory until they are cleared.
Alarm Delay	There is a user-programmable time delay before an alarm is registered on a metering or status channel. The delay can be set anywhere from 1–99 seconds.
Auto-logging	If your VRC2000 is equipped with a Data Interface, the system can be configured to automatically dial an outbound telephone number (or key on a two-way radio system), turn on the Data Interface, and transmit all metering and status channel readings to a PC running Setup VRC2000 software (DOS) in terminal mode or VRC-Win software (Windows®).
Automatic Commands	Up to 64 time-of-day functions can be programmed into the VRC2000. These automatic commands are based on a 24-hour clock, and can be used to automatically activate any of the command channels 32 switches.
Battery	The Internal Lithium battery provides power to back up the system RAM and real-time clock. The battery is not connected at the factory, and must be properly connected with a Berg jumper for operation.
Calibration Constant	Calibration constants are one of the parameters associated with metering channels. The calibration constant is used to obtain actual voltage or current readings based on a sample. For example, with a voltage sample of 5V (which represents an actual value of 5,000V), program the calibration constant of 1,000. Another option is to program a calibration constant of one, and use a unit identifier of KILO VOLTS.
Channel Identifiers	Two words can be programmed into the VRC2000 to identify metering and/or status channels. Default is two five-millisecond silences.
Clock	The VRC2000 has a real-time clock and calendar which is used to tag all VRC2000 alarms. This clock must be set accurately. The clock can also be set to automatically accommodate daylight-savings time.
Command Channels	The VRC2000 has 16 command channels which can be used to turn equipment on/off, raise/lower power or voltage settings, or anything else that can be controlled through open collector outputs.
Command Channel Switches	Each command channel has two switch outputs (A and B). The switch outputs are open collectors that can be programmed to be either momentary or latching.
Command Relay Unit	Accessory allowing open collectors for all command-channel outputs. See Appendix C: Accessories (Page 100).

Current Samples	To change the metering-channel inputs to read current (rather than voltage), properly place a Berg shorting jumper across the desired metering channel's dual-row post.
Data Interface	This accessory includes a 2,400bps internal modem plus a RS232 serial COM port. See Appendix C: Accessories (Page 100).
Default Command Channels	Any command channel can be tied to any metering channel. This allows commands to be issued immediately after requesting information about a metering channel.
Dial-Tone Wait	Some older telephone systems or systems with poor quality lines do not have reliable prevision dial tone. In such cases, the VRC2000 can be programmed to wait six seconds before beginning to dial an outbound telephone number.
Disarm Functions	See Mute Functions.
DTMF	Dual-tone multi-frequency (touch-tones by AT&T) for dialing on the phone system.
FCC Registration Number	The VRC2000 us registrered with the FCC, and is governed by FCC Rules and Regulations Part 68 regarding devices to be connected to the switched telephone network. The FCC registration number and ringer equivalency numbers appear on a printed label attached to the VRC2000 chassis.
First Low Limit	The first low limit is the low value closest to the nominal value set for each metering channel. See also Tolerance Limits.
First High Limit	The first high limit is the high value closest to the nominal value set for each metering channel. See also Tolerance Limits.
Four-Wire Connections	Using a four-wire connection, all VRC2000 functions can be accessed with a dedicated line. The DTMF tones required for VRC2000 operation will be sent over this hard-wired circuit via two BNC connectors on the back panel.
Inactivity Timer	When the inactivity timer is active, the VRC2000 must receive at least one valid DTMF command every five minutes or it will automatically exit set-up/user/operator mode. If the inactivity timer is inactive, the unit will exit set-up/operator mode after one hour if it has received no DTMF commands; user mode will only be exited when the line is properly hung up or the user has properly signed off.
Indirect Meter Readings	A metering channel defined as an indirect output multiplies the readings of the two previous consecutive metering channels together. Indirect inputs are used primarily to calculate power readings.
Internal Lithium Battery	See Battery.
Latching	A control signal (in this case, a command-channel output) that remains in a fixed state until you release it. This is opposed to a momentary control which is a pulsed signal.
LED	Light Emiting Diode. A semiconductor diode used in an electronic display that emits a light when subjected to an applied voltage.
Linear Metering Readings	A metering channel defined as a linear input multiplies the sample voltage by a mathematical constant. See also Calibration Constant.
Local User Mode	Local modes are used when you are on-site with your VRC2000. User modes allow readings to be taken from metering/status channels, and commands to be issued via

Appendix A:
Continued 

	command-channel outputs.
Message-Only Function	The message-only function will allow the VRC2000 to call a number and only leave a message to return the call.
Metering Channel	The VRC2000 has 16 analog inputs called metering channels. What the VRC2000 says when reporting metering-channel readings is user programmable.
Momentary	A control signal (in this case, a command-channel output) that pulses at a programmed rate. The number to be programmed represents the number of one-eighth seconds to activate a momentary switch. This is opposed to a momentary control which is a fixed signal.
Multiple-Response Reports	The VRC2000 can be programmed to provide six consecutive responses, each at eight-second intervals, for metering and status channels. Each response is accurate as of the time of the response. See also Single-Response Reports.
Mute Functions	A mute function will disable all alarms and automatic commands associated with any status or metering channel.
Operator Access Code	This code allows metering and status-channel readings to be taken. Commands cannot be issued and alarms cannot be cleared.
Outbound Telephone Number	The VRC2000 can be programmed to automatically call certain telephone numbers to report alarm conditions.
Output Configurations	For each outbound telephone number, you can select whether it will report an alarm using the VRC2000's electronic voice or using the modem section of the Data Interface. Whether a telephone line or two-way radio is used to transmit this information can also be selected.
Pinouts	Configuration of signal-carrying lines on a connector.
Power Meter Readings	Metering channels defined as power samples mathematically square the input to the metering channel, then multiply the result by the Calibration Constant. See also Calibration Constant.
Precision Dial Tone	See Dial-Tone Wait.
PTT	See Push-To-Talk Outputs.
Push-To-Talk Outputs	A PTT output appears on pin 19 of both of the VRC2000's back-panel command-channel output connectors. These outputs are pulled low whenever the VRC2000 has data in its voice buffer, indicating that it has alarms to report.
Radio-Mode Operation	A two-way radio can be connected to a VRC2000 system, eliminating the need for any standard telephone line. All VRC2000 functions can be accessed via this connection.
Real-Time Clock	See Clock.
Reports	See Single-Response Reports. See Multiple-Response Reports.
Ring Count	The VRC2000 can be programmed to answer incoming calls after a certain number of rings: a "ring count."
Ringer Equivalency	See FCC Registration Number.

Second High Limit	This is the highest tolerance limit the metering channel will monitor. See also Tolerance Limits.
Second Low Limit	This is the lowest tolerance limit the metering channel will monitor. See also Tolerance Limits.
Security Levels	The VRC2000 provides three security levels: operator, user and system. <i>Operator</i> access allows metering and status-channel readings to be taken. <i>User</i> access allows metering and status-channel readings to be taken; commands can be issued, and alarms can be cleared. <i>System</i> access allows setup of any metering/status/command channel, changing of VRC2000 programming and access codes; commands cannot be issued, and readings from status and metering-channel inputs cannot be taken.
Sequence-Output Programs	The VRC2000 allows up to four separate sequences of up to 32 keystrokes (DTMF commands) to be programmed. These mini programs are stored in the unit and can be triggered with DTMF commands.
Setup VRC2000 Software	This software is an easy-to-use DOS software package. See Appendix C: Accessories (Page 100).
Silence Sensor	Absolute carrier control is required by the FCC when the VRC2000 is used as the primary remote control system for a transmitter and is accessed via telephone line. The Silence Sensor provides absolute carrier control. See Appendix C: Accessories (Page 100).
Single-Response Reports	A single-response report is where the VRC2000 sends only a single response to report the readings coming from a status or metering channel. See also Multiple-Response Reports.
Sound Sensor	The VRC2000 comes with a built-in condenser microphone built into its front panel. This microphone can be activated at any time to listen to sounds being generated in the vicinity of the VRC2000.
Status Channels	The VRC2000 has 16 status-channel inputs, each of which can be high (open) or low (closed). The VRC2000 can be programmed with desired words to describe the information gathered from a status channel.
System Access Code	The system access code allows setup of any metering/status/command channel, changing of VRC2000 programming and access codes; commands cannot be issued, and readings from status and metering-channel inputs cannot be taken.
System Identifier	The 20-word statement a VRC2000 makes when a user signs onto the system can be customized to suit application needs.
Telephone Interface	Several options are available to make the VRC2000 function with your particular telephone system. Options include selection of pulse/DTMF dialing, ring count, inactivity timer and dial-tone wait. See also Ring Count, Inactivity Timer, Dial-Tone Wait.
Telephone Surge Protector	This accessory comes as part of the VRC2000 system, although additional are suggested for replacement of others damaged by lightning strikes, etc. See Appendix C: Accessories (Page 100).
Temperature Probe	Up to four temperature probes can be connected to the Temperature Sensor accessory. See Appendix C: Accessories (Page 100).
Temperature Sensor Unit	See Temperature Probe.
Time-Of-Day Functions	See Automatic Commands.

Appendix A:
Continued 

- Tolerance Limits** Up to four tolerance limits for each metering channel can be programmed. Two of these limits must always be below the nominal value set for each metering channel; two of these values must always be above the nominal value.

- Two-Way Radio Connections** See [Four-Wire Connections](#).

- User Access Code** The user access code allows metering and status-channel readings to be taken; commands can be issued, and alarms can be cleared.

- Voice Mode** The VRC2000's voice mode can be turned ON/OFF to help speed VRC2000 programming.

- VRC-Win Software** This software is an intuitive point-and-click Windows® software package. See Appendix C: Accessories ([Page 100](#)).

- Wiring Interface** This accessory provides an alternative to the standard DB37 connectors on the VRC2000's back panel. See Appendix C: Accessories ([Page 100](#)).

- Word List** The VRC2000 incorporates a special electronic-speech package that allows the system to talk over any telephone line. This speech package has a vocabulary of almost 800 words. See Appendix I: Word List ([Page 125](#)).

Appendix B: Connector
Pinouts 

Table 15. Command 1–8 Pinout

<u>Pin</u>	<u>Description</u>
1	Command 1A
2	Command 1B
3	Command 2A
4	Command 2B
5	Command 3A
6	Command 3B
7	Command 4A
8	Command 4B
9	Command 5A
10	Command 5B
11	Command 6A
12	Command 6B
13	Command 7A
14	Command 7B
15	Command 8A
16	Command 8B
17	+5Vdc through internal 220ohm resistor
18	+5Vdc through internal 220ohm resistor
19	PTT
20–37	Ground

Table 16. Command 9–16 Pinout

<u>Pin</u>	<u>Description</u>
1	Command 9A
2	Command 9B
3	Command 10A
4	Command 10B
5	Command 11A
6	Command 11B
7	Command 12A
8	Command 12B
9	Command 13A
10	Command 13B
11	Command 14A
12	Command 14B
13	Command 15A
14	Command 15B
15	Command 16A
16	Command 16B
17	+5Vdc through internal 220ohm resistor
18	+5Vdc through internal 220ohm resistor
19	PTT
20–37	Ground

Table 17. Metering Pinout

<u>Pin</u>	<u>Description</u>
1	Metering 1
2	Metering 2
3	Metering 3
4	Metering 4
5	Metering 5
6	Metering 6
7	Metering 7
8	Metering 8
9	Metering 9
10	Metering 10
11	Metering 11
12	Metering 12
13	Metering 13
14	Metering 14
15	Metering 15
16	Metering 16
17–19	+5Vdc (220ohm current limited)
20–37	Ground (+/- volt reference)

Appendix B:
Continued 

Table 18. Status Pinout

<u>Pin</u>	<u>Description</u>
1	Status 1
2	Status 2
3	Status 3
4	Status 4
5	Status 5
6	Status 6
7	Status 7
8	Status 8
9	Status 9
10	Status 10
11	Status 11
12	Status 12
13	Status 13
14	Status 14
15	Status 15
16	Status 16
17-37	Ground (+/- volt reference)

Appendix C:
Accessories 

A complete line of accessories is available from Gentner Communications to allow you to customize your VRC2000 system to most effectively and efficiently meet your needs.

The VRC2000 is supported by a complete line of accessories and options. For more information, contact Gentner Communications.

Software**VRC-Win**

VRC-Win is designed to work with any 386 (with a math coprocessor), 486DX or better computer system. The Windows®-compatible VRC-Win software supplements the VRC2000 and allows all information to be entered via computer and displayed on a monitor in the intuitive point-and-click Windows® environment. *Gentner Part Number: 910-084-100*

Setup VRC2000

This easy to use, menu-driven DOS software package will run on 100 percent IBM-compatible computers. With it, you can quickly program or reprogram your VRC2000 without using a DTMF telephone. Setup VRC2000 also includes a terminal emulation program which you can use to directly monitor and control the VRC2000 in conjunction with the Data Interface accessory.

The Setup VRC2000 DOS software package is *free* for download from the Gentner Web Site. Connect to <http://www.gentner.com>, click the TECHNICAL SUPPORT button, access the SITE CONTROL page, then select Setup VRC2000 software download. Or contact Technical Support at one of the numbers listed at the bottom of the page and request it by part number. *Gentner Part Number: 910-084-200*

Hardware

AC Current Sensor

This accessory allows you to accurately measure current samples from AC power lines. Use the AC Current Sensor to check the status of tower lights, incoming AC power or the power output of your standby power generator. The AC Current Sensor provides an analog output which you can connect to a VRC2000 metering-channel input. *Gentner Part Number: 910-093-001*

Command Relay Unit

The standard VRC2000 remote control unit provides open collectors for all command channel outputs. This accessory converts the open collectors to relay contact closures with Phoenix® connectors. Each relay is rated at 5A, up to 240V, noninductive. One Command Relay Unit will interface with eight VRC2000 command channels. *Gentner Part Number: 910-085-120*

Data Interface

The Data Interface includes a 2,400 bits per second (bps) internal modem plus a 2,400 bps RS232 serial communications port. This accessory allows you to communicate directly with the VRC2000 through a PC running Setup VRC2000 software (in the terminal mode) or VRC-Win software. You can make this connection directly using the RS232 port or over standard telephone lines through a modem. *Gentner Part Number: 910-076-201*

Silence Sensor

Absolute carrier control is required by the FCC when the VRC2000 is used as the primary remote control system for a transmitter and is accessed via the telephone network. The Silence Sensor gives you absolute carrier control by monitoring the program audio feed to the transmitter.

Gentner Part Number: 910-074-001

Telephone Surge Protector

The VRC2000 comes equipped with the VRC2000 Telephone Surge Protector. You may want to order a spare Telephone Surge Protector in case the original unit is damaged by a lightning strike or other voltage surges.

Gentner Part Number: 910-072-050; 900-072-050 (Parts Kit)

Temperature Sensor

The Temperature Sensor can be directly interfaced with the VRC2000 to allow you to monitor the internal environment of your transmitter building, the outside temperature, the temperature inside your equipment rack, or even the temperature at the top of the tower. Use it to automatically turn on de-icing equipment or sound an alarm due to overheating. The Temperature Sensor accurately measures up to four temperatures simultaneously over a range of -50–250° F. The unit is available in either Fahrenheit or Celsius versions. The Temperature Sensor Unit comes equipped with Temperature Probe with a 12-foot cable. *Gentner Part Number: 910-091-001 (Temperature Sensor plus one Fahrenheit probe); 910-091-003 (Temperature Sensor plus one Celsius probe)*

Temperature Probe

You can connect up to four Temperature Probes to the Temperature Sensor Unit. Each Temperature Sensor Unit comes equipped with one Temperature Probe. *Gentner Part Number: 910-091-001 (Fahrenheit probe); 910-093-001 (Celsius probe)*

Appendix C:
Continued ≡

Wiring Interface

This accessory provides an alternative to standard DB37 connectors to the VRC2000. It brings connection points to all VRC2000 status/meter/command channels via Phoenix® connectors.
Gentner Part Number: 910-085-110

Appendix D: Theory
of Operation ≡

The VRC2000 is designed to provide accurate, dependable, and inexpensive remote supervision and control of many types of equipment and facilities. The unit uses CMOS integrated circuits to provide for low power consumption and minimal generation of internal heat. The VRC2000 consists of the following major building blocks:

- MC146805 Microcontroller
- Firmware (Operating System)
- Digital Voice Synthesizer
- Command Channel Outputs
- Metering Channel Inputs
- Status Channel Inputs
- Real-Time Clock
- DTMF Generator/Detector
- Telephone Interface

Figure 27 (below) is a block diagram of the VRC2000 system.

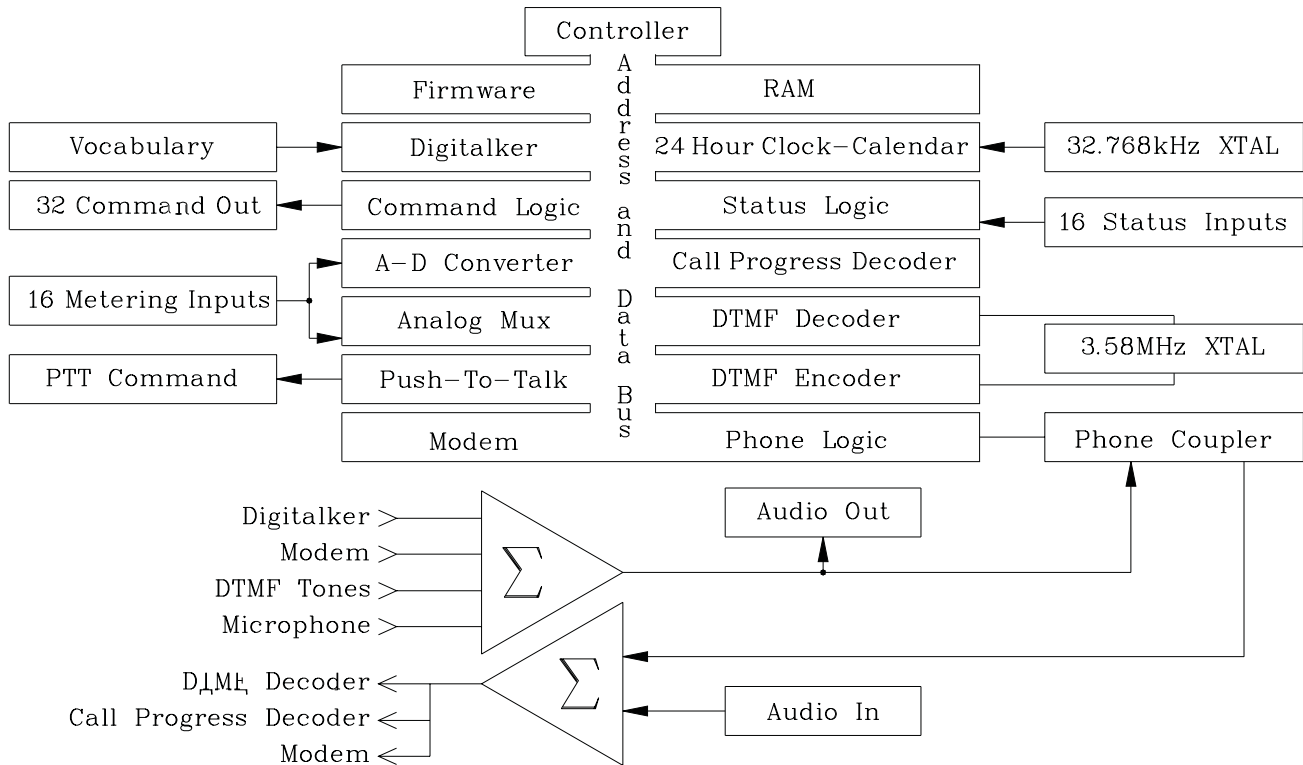

Figure 27. VRC2000 block diagram

All circuitry is contained on a single four-layer printed circuit board (PCB). Layers one and four (top and bottom) contain traces that convey signal-level information. Three power-supply traces are on the third layer from the top. The second PCB layer is exclusively the ground plane. Along with ferrite beads and series inductors on all inputs and outputs, this design provides excellent RFI protection.

Each of the building blocks will be discussed in the following text. During this discussion, refer to the electrical diagrams in Appendix J: Schematics (Page 129).

Microcontroller Theory

The VRC2000's central processing unit (CPU) is a MC146805E2 controller. It has external and timer interrupts, and it consumes very little power. The MC146805 accesses 8K of memory but, by address decoding, the unit is able to support additional ROM/RAM to allow for addressing the digital voice synthesizer's word library.

The chip-enable logic used in the VRC2000 is outlined in Table 19 (below).

Table 19. VRC2000 Chip-Enable Logic

<u>Identity</u>	<u>Function</u>	<u>Destination</u>
IOEN*	Modem	Data Interface
SPCCMDWR*	Speech Command Write	U6 74HC574 Clock
SPCADRWR*	Speech Address Write	U5 74HC574 Clock
ADCMDWR*	A/D Command Write	U38 74HC574 Clock
CMDDDTDWR*	Command Data D Write	U53 74HC574 Clock
CMDDDTCWR*	Command Data C Write	U51 74HC574 Clock
CMDDDTBWR*	Command Data B Write	U49 74HC574 Clock
CMDDDTAWR*	Command Data A Write	U47 74HC574 Clock
ADDTHRD*	A/D Data High Byte Read	U37 AD573 HBE*
ADDTLRD*	A/D Data Low Byte Read	U37 AD573 LBE*
STSdTARD*	Status Data A Read	U39 74HCT541 G1*, G2*
STSdTBRD*	Status Data B Read	U40 74HCT541 G1*, G2*

* Denotes Active Low Input

The SPCCMDWR* enables the MM54104 digital voice synthesizer when active, and the SPCADRWR* controls the address selection of which word ROM the digital voice synthesizer is accessing. The ADCMDWR* enables the demultiplexer used on the metering channel inputs while the ADDTHRD* and the ADDTLRD* lines control which data byte is accessed.

The four CMDxxxx* enable lines each control eight command-channel switches configured in four channels of two switches each. CMDDDTAWR* controls command channels 1–4's switch functions (*, #); CMDDDTBWR* controls command channels 5–8's switch functions, and so on. The status channel enable lines STSdTARD* and STSdTBRD* each control half of the 16 status-channel inputs.

The microprocessor master clock runs at 4MHz. The 256Hz pulses that U25 (a MC146818 clock) generates are critical to the interrupt service routines.

U29 (a 74HC541 tristate input port) decodes the VRC2000's eight hardware interrupts. These interrupts are prioritized as outlined in Table 20 (next page, top).

Appendix D:
Continued 

Table 20. Hardware Interrupt Prioritization

<u>Priority</u>	<u>U29 Bit</u>	<u>Description</u>
1st	A8-Pin 9	Real Time Clock (U25, MC146818)
2nd	A7-Pin 8	Modem
3rd	A6-Pin 7	Interrupt A
4th	A5-Pin 6	Interrupt B
5th	A4-Pin 5	DTMF Decoder (U18, SSI202)
6th	A3-Pin 4	Call Progress Decoder (U13, NE5900)
7th	A2-Pin 3	Ring Detect/Loop Sense (U42, 4N37)
8th	A1-Pin 2	Speech Interrupt (U12, MM54104)

The microprocessor RST (reset) line is controlled by both the 24-hour clock, as well as the standby battery-switching network. The VRC2000 was designed to clamp the microprocessor's reset line low whenever the 5Vdc regulator (VR1) drops below 4Vdc, which corresponds to the AC input/line voltage being a approximately 72Vacrms. This reset/switching network halts the processor, as well as battery backing up the RAM (user database) and the real-time clock. This battery backup is provided by the internal 3.6Vdc lithium battery.

Telephone Logic and Interface

The VRC2000 includes an automatic telephone coupler. Coupling to the telephone line is accomplished by rectifying ringing voltage to a logic level and by monitoring loop current. The unit will detect an inbound call when the AC ringing voltage appears across tip and ring of the LINE telephone jack. The bridge rectifier, 8R2, smooths the ringing pulses at the U42 input, an 4N37 opto-isolator which, in turn, triggers the processor ring detect/loop sense interrupt by driving its output (pin 5) low. The unit will then answer the line at the programmed number of rings.

Once the VRC2000 is online (telephonenumber is terminated) loop current flows. This also holds the output of the opto-isolator low. For remote disconnect (hang up) the VRC2000 monitors current reversal or loop-current drop. If either of these occurs, the unit will return to an on-hook condition. The VRC2000 uses a NE5900 call-progress decoder to aid in monitoring line conditions.

The VRC2000 employs a PREM SPT-183 coil as a hybrid coupler. The microprocessor controls the relays K1 and K2 to provide telephone-line connection to the coil, or provide voltage to the SET jack in set-up mode.

With Part 68 Registration, limited RFI filtering is provided on the LINE input. In high RFI fields, additional protection may be required to eliminate demodulation by the bridge rectifier (BR2) of RFI present on the phone line.

The VRC2000 can be set up to dial up to five telephone numbers when reporting alarm conditions. The telephone numbers are always dialed in sequence, one through five, with a 60-second pause between each number. After the last number, the VRC2000 pauses for 10 minutes before redialing the first number. If a faster repeat is desired, enter the same telephone

number in several locations. The user can also direct alarms occurring on specific channels to report to a specific telephone number in the outbound telephone number stack.

Unbalanced Audio Output

The VRC2000's BNC connectors located on the unit's rear panel provide auxiliary audio connections. The connector labeled AUDIO IN is paralleled with the telephone-receive audio. The BNC marked AUDIO OUT contains the send audio. For electrical specifications, see Specifications (Page 90).

Status Channel Inputs

There are 16 status-channel inputs on the VRC2000. These inputs are designed to accept either a TTL level or a dry contact closure. The status-channel input is labeled STATUS on the VRC2000 rear panel. This connector is a DB37M.

U39 and U40, 74HCT541 octal-line drivers, are used to output the status-channel data onto the address/data bus. U39 monitors the condition of status channels 1–8, and U40 is tied to status channels 9–16.

The operating input levels of the 74HCT541 are 0–0.8Vdc for logic 0 and 2–5Vdc as logic 1. The absolute maximum input range of this chip is -0.2–5.2Vdc. Since the VRC2000 reads status-channel inputs once every second, it is recommended that a logic transition last at least one second to ensure correct detection.

A section of the VRC2000's memory map is dedicated to storing the condition of each status-channel input. This table is recalled when status channels are accessed via the appropriate DTMF tones.

Metering Channel Inputs

There are 16 metering-channel inputs on the VRC2000. Each metering channel is programmable to measure -5–5Vdc or 0–10Vdc. Each metering-channel input can also be internally jumpered to read -5–5mA or 0–10mA for full scale. The input to the unit's metering system is labeled METERING.

Each metering-channel input can measure linear, power-to-linear or calculate indirect power. When measuring a linear potential, the result of the A/D conversion is given. With power-to-linear conversion, a metering channel's input voltage will undergo a numeric conversion from that of an exponential factor of a power meter to a linear presentation.

Indirect power conversion takes the two previous consecutive metering channels and multiplies them together to produce a numeric presentation. For instance, an indirect power conversion could be used to calculate the power output of a piece of equipment by multiplying voltage by current.

U32 (an AD7506 multiplexer) is used as a switching network at the metering-channel inputs. The AD7506 output contains the analog representation of the input selected via the four address lines, A0–A3 or metering channels 1–16. U37 (an AD573) is a successive approximation analog-to-digital converter. Analog-to-digital conversion is done on a binary weighted scale. Each of the 10 binary bits (1024) is compared with the input

Appendix D:
Continued 

until the closest value is found. The AD573 has a high-byte enable (HBE) and a low-byte enable (LBE), which allows the processor to read 10 bits of data for each metering channel, rather than the normal eight bits.

Just like the status channels, the VRC2000 stores the data of all metering-channel inputs in memory for quick processing and easy access.

Command Channel Outputs

The VRC2000 has 32 outputs configured into 16 command channels with two commands each. Each of these outputs are open collector drivers rated to 48Vdc at 250mA (noninductive). Each switch can be programmed as latching or momentary. When a command channel is programmed to be momentary, the output can be enabled for .125–32 seconds via user programming.

U48, U50, U52 and U54 (all ULN2BO3A Darlington pair drivers) are devices providing the 32 command-channel switches.

Real-Time Clock

The MC146818 time-of-day clock (U25) pulses the microprocessor at the critical 256Hz rate to allow time-of-day functions, and report the operator the time and date an alarm was detected. Y3 (a 32.768KHz crystal) controls the clock's accuracy. By adjusting C46 (a trimmer capacitor) this clock is set at the factory to 32.768KHz +/- .3Hz. No further adjustment should ever be needed. This keeps the time of day accurate to within two seconds per month.

DTMF Encoder/Decoder

To make the VRC2000 operate on the toll grade dial-up telephone network with the capability of both sending and receiving data using DTMF tones, a SSI202 DTMF decoder and a MK5089 DTMF generator are used. The SSI202 (U18) and MK5089 (U35) are both clocked by the 3.58MHz crystal (Y2).

The SSI202 decoder has a receive-level window of 40dB, centered at -20dBm. This allows for both local and long-distance access. Typical local loop signals arrive at the SSI202's analog input at -4--6dBm. Long-distance calls typically have a level of -15dBm.

The MK5089 is used in conjunction with U13 (a NE5900) to generate and monitor outbound alarm reporting telephone calls and for auto-logging functions. The MK5089 DTMF generator initiates the call while the NE5900 is a call-progress decoder.

The NE5900 is a narrow bandpass filter which monitors the power in the telephone band to detect the following conditions:

- Ringing
- Reorder
- Fast Busy
- Slow Busy
- Dial Tone

These conditions inform the VRC2000 whether outbound calls have been terminated (answered) or not.

Digital Voice Synthesizer

The VRC2000's synthesized voice reporting is done by National Semiconductor's Mozer MM54104 digital voice synthesizer. This integrated circuit is a Vocorder (energy from an actual human voice recording is broken down into bits, synthesized to recreate an addressable vocabulary word by word).

Refer to Appendix J: Schematics (Page 129) for digital voice synthesizer circuitry. U12 is the MM54104 and its associated memory (U1, U3, U8 and U10). These memory devices are 27C256 EPROMs, which contain almost 800 words (library/vocabulary) accessible to the unit.

Power Supply

The VRC2000 was designed to operate on an AC line of either 117Vac or 234Vac. Selection of line voltage is accomplished by selecting the proper Molex connector, which ties the line cord to the VRC2000's transformer.

The AC line transformer produces two output levels at its secondary windings. One is 31Vrms, which is rectified and input to the linear regulators; the other, 17Vrms, powers the digital regulator.

The digital circuitry on the VRC2000'S PCB is powered by VR1, a 7,805K 5Vdc regulator. VR2 and VR3 provide +/-12Vdc (7812T and 7912T) for the linear chips. The digital voice synthesizer operates at a VDD of 9Vdc, so a 1N5223, 2.7V Zener diode is in series with its supply line.

The MC146818 clock and the RAM (U27, a HM6264) are both powered by the 3.6Vdc internal-lithium battery when the AC line drops below 72Vrms.

VRC2000 Unit

The VRC2000 is a microprocessor-based system (MC146805E2) which permits conventional remote control of broadcast transmitters and other equipment as well as automatic transmission systems (ATS) operation. The system's internal Central Processing Unit (CPU) and memory circuitry allow the VRC2000 to be set up by the user to make decisions and take actions based on predetermined criteria, provide telemetry to the user, or to respond to commands directly.

DTMF Control

The VRC2000 is primarily controlled by standard telephone DTMF signals. When receiving instructions, the VRC2000 responds in plain English with its internal digital-voice synthesizer. The VRC2000 has a vocabulary of almost 800 words, numbers, prefixes, and suffixes. (See Appendix I, Page 125.) You may program the VRC2000's voice responses during the set-up operation (VRC2000 Setup, Page 10).

An automatic telephone coupler is built into the VRC2000. This device senses telephone company ringing and disconnect signals, providing automatic connection to and disconnection from the dial-up telephone line. The VRC2000 can also dial out to a preprogrammed telephone number with either DTMF or pulse signals. The VRC2000 comes standard with additional four-wire connections to allow use with almost any bidirectional audio link.

The VRC2000 may be programmed to automatically dial to up to five telephone numbers upon the presence of an alarm condition, using either pulse dialing or DTMF. The system will also automatically answer incoming telephone calls based on a programmed number of rings.

Real-Time Clock and Memory

The VRC2000 incorporates a highly accurate real-time clock and calendar. Internal lithium battery maintains real-time clock and user memory (non-volatile CMOS RAM). These allow the VRC2000 to tag registered alarms with the time of day and date, and to perform automatic functions according to the time of day, day of week or date.

Inputs

The VRC2000 contains a number of different types of inputs: metering, status and command. These inputs (channels) can be connected to your transmitter and/or other equipment to provide a complete and accurate picture of how attached equipment is operating.

Metering Channels

The VRC2000 has 16 metering-channel inputs. These inputs accept an analog voltage or current sample; the VRC2000's internal circuitry converts these samples into four-digit numbers, which the system can then report over the telephone line. Each metering channel can be set up with four tolerance (threshold) limits, two upper and two lower. You can also program the system to issue an automatic command from any of these tolerance limits. You may also set up the VRC2000 to recognize any tolerance limit as an alarm condition.

Each metering channel can be calibrated in a linear numeric value proportional to input or a power-to-linear conversion of input. Each metering channel may also be programmed to read indirect power — the multiplication of two consecutive channels, with the resultant appearing in the third channel as a new calibrated value. Input impedance on each metering channel is 100kOhms.

Status Channels

The VRC2000 also contains 16 status-channel inputs. Each of these inputs has two conditions: the status-channel inputs are either high or low. Either state may be declared an alarm condition, and any status channel can be programmed to mute any metering or status channel.

Mute Capability. Any status channel can be programmed to override (defeat) the alarm limits set on any metering or status channel (any automatic command associated with such a tolerance limit will also be defeated). A total of 40 mute functions are available.

Command Channels

Sixteen command channels (with two switches each) are standard in the VRC2000. This configuration provides you with a total of 32 possible commands. These command channels allow commands to be sent to transmitter or other equipment over the telephone lines with a standard DTMF telephone. The command channel outputs on the VRC2000 are open-collector drivers, and each command channel may be programmed to be either latching or momentary. Momentary commands can be set up to last from .125 to 31.875 seconds in increments of one-eighth (.125) of a second.

Commands can be activated manually in real time over the telephone, or they can be set up to activate automatically based on the condition of selected metering or status channel. Commands can also be triggered by the built-in real time clock as time-of-day events.

Automatic Commands. Automatic commands may be initiated by any of three sources: status-channel conditions (activated or deactivated), exceeded tolerance limits on any metering channel, or by up to 64 preprogrammed time-of-day functions.

Appendix F: Remote/ Local Tutorial

The following exercises will help you understand how the VRC2000 operates in the local and remote modes. See Also Remote/Local Modes ([Page 5](#)).

Local Mode

The following examples will help you understand how the VRC2000 operates in the local user mode. A dial-up telephone line is not required for the local user mode, although the Initialization procedure should already be complete ([Page 6](#)).

With a standard DTMF telephone connected, power up the VRC2000. Pick up the telephone handset and listen, then push in the LOCAL/REMOTE button [3] ([See Figure 28, below.](#)) on the VRC2000's front panel. The button will light red.

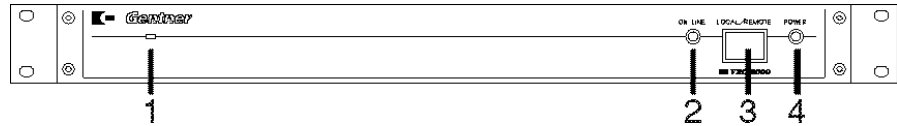

Figure 28. VRC2000 front-panel controls

LOCAL/REMOTE NOTE:

This button must remain ON as long as you require local control of the VRC2000.

You will hear the VRC2000 say

- SETUP ENABLED. PLEASE ENTER SYSTEM ACCESS CODE.

Immediately following this message, use the telephone's DTMF pad to enter the following sequence of numbers:

☎ "1 2 3 4 5 6 7"

If you entered this sequence correctly, the VRC2000 will respond:

- THANK YOU. PLEASE SELECT FUNCTION FOR PROGRAMMING.

ACCESS CODE NOTE:

If the access code was entered incorrectly, the VRC2000 will stop supplying power to your telephone handset. The VRC2000 will allow you only one attempt to enter the proper access code. To re-enter the access code, press the LOCAL/REMOTE button [3] to return to remote mode, then press the button again to attempt local connection again.

Once you have properly entered the access code and gained access to the VRC2000, you are in the Local Setup mode. Local Setup allows you to program various functions into your VRC2000. For now, switch immediately into the Local User mode to avoid entering unwanted programming information into the VRC2000.

To enter the Local User mode, enter the following sequence on your DTMF phone:

☎ "9 2 0"

The VRC2000 will respond:

- USER ENABLED.

Now you can enter commands using the telephone DTMF pad that will cause the VRC2000 to take readings, report pending alarms or activate command-channel outputs.

To check on pending alarms, enter the following sequence on your DTMF pad:

☎ “0 0 0”

The VRC2000 will respond:

- NO ALARMS PENDING.

ALARMS PENDING NOTE:

No alarms are pending since the VRC2000 has not yet been set up for alarm reporting. Instructions for setting up alarms are covered in VRC2000 Setup (Page 10). If the VRC2000 reports an alarm at this point, make a note of exactly what the unit says.

Now enter the following sequence on your DTMF pad:

☎ “1 1 1”

The VRC2000 will respond:

- ERROR.

The sequence just entered is not a valid instruction. Whenever you hear an ERROR message, wait a second and then re-enter a valid sequence.

Now enter

☎ “6 0 1 *”

The VRC2000 will respond:

- METERING CHANNEL ONE ... POINT ZERO, ZERO, ZERO, ZERO, VOLTS.

The VRC2000 is reporting the current input condition of metering channel 1. Since the VRC2000 has not been fully set up yet, no further message will be heard. After the unit is set up, the VRC2000 will tell you the exact electrical condition of metering channel 1.

Now enter

☎ “6 1 6 *”

The VRC2000 will respond:

- METERING CHANNEL SIXTEEN ... POINT ZERO, ZERO, ZERO, ZERO, VOLTS.

Now enter

☎ “7 0 1 *”

The VRC2000 will respond with the current condition of status channel 1.

Appendix F:
Continued 

Now enter

☎ “7 0 8 *”

The VRC2000 will report the current condition of status channel 8.

Now enter

☎ “2 0 1 *”

The VRC2000 will respond:

- COMMAND CHANNEL ONE. A ACTIVATED.

The VRC2000 is reporting that command channel 1’s A switch is energized.

Now enter

☎ “2 0 2 * # *”

The VRC2000 will respond:

- COMMAND CHANNEL TWO. A ACTIVATED. B ACTIVATED. A ACTIVATED.

The sequence instructed the VRC2000 to activate command channel 2’s A switch and B switch, and then to activate the A switch again.

VOICE RESPONSE NOTE:

Although the voice report from the VRC2000 took several seconds, the command channel switches are activated immediately after you press the “” or “#” buttons on your telephone.*

Now enter a longer sequence:

☎ “6 1 0 * 6 1 1 * 7 1 2 *”

Listen to the response.

This demonstrates the VRC2000’s capability to accept long sequences of commands. As long as valid instructions are sent, the VRC2000 will continue to process the commands and respond to the user. All valid commands are executed immediately, even though the voice output of the unit may take some time.

If you enter an invalid command, the VRC2000 will respond with the ERROR message.

VOICE BUFFER NOTE:

The VRC2000’s electronic voice buffer can hold only 128 words. If the voice buffer is filled beyond this capacity, some of the words will not be reported. All commands, however, will be executed.

Now enter

☎ “0 6 0”

The VRC2000 will respond with the system date and time. Since the real-time clock has not yet been set, the date and time reported will be based on the unit's default parameters.

Now press the LOCAL/REMOTE button on the VRC2000's front panel (it will dim). The VRC2000 will respond:

- SETUP DISABLED. GOOD-BYE.

By returning to remote mode, you are signing off from the local mode.

Remote Mode

With the VRC2000, you can control all functions from any DTMF telephone over a standard dial-up telephone line (one connected to the VRC2000, the other connected to a separate DTMF telephone — *not* the one connected to the VRC2000 back panel). Initialization should be complete before this point ([Page 6](#)).

From the second telephone, call your VRC2000. After the second ring, the VRC2000 will automatically answer your call and say:

- HELLO. THIS IS THE VRC2000 WITH VOICE, MODEM OR RADIO ACCESS. PLEASE ENTER ACCESS CODE.

Now use your telephone's DTMF pad to enter the default user access code:

☎ "1 2 3 4 5"

ACCESS CODE NOTE:

Notice that this is a different code than you used in the Local Mode tutorial ([Page 110](#)).

The VRC2000 will respond:

- THANK YOU. NO ALARMS PENDING.

This indicates that you have successfully accessed the VRC2000 from a remote location over the telephone. The user access code indicated above is the factory-set default code. If you are unable to access the VRC2000 with the default user access code, try powering down the VRC2000 and reconnecting the internal lithium battery ([Step 2, Page 7](#)).

The VRC2000 responds to the same commands in the remote mode as it does in the local mode. Try some of the commands now that you tried earlier in the local mode.

When you are done experimenting with commands in the remote mode, enter the remote user sign-off code:

☎ "9 9 9"

The VRC2000 will respond:

- GOOD-BYE.

Appendix F:
Continued ≡

This indicates that you have successfully signed off from VRC2000 remote user mode.

Appendix G: Time-Of-Day
Function Tutorial ≡

The following exercises will familiarize you with programming time-of-day functions.

Exercise 1

In the following exercise, program time-of-day function three to activate the A switch for command channel 8 every day for the month of November at 11:59:01 p.m.

TIME-OF-DAY PROGRAMMING NOTE:

Enter the #” symbol after the proper access code to program time-of-day functions. Entering the “” symbol will disable that time-of-day function.*

The VRC2000 will report only a single [BEEP] after a set-up parameter if you do not make a new entry. If you do make a new entry, the VRC2000 will [BEEP] twice.

Enter

☛ “3 0 3 #”

The VRC2000 will respond:

• TIME-OF-DAY HOURS FOR ENTRY THREE ARE ... {TEN}

You enter

☛ “1 1”

The VRC2000 will respond with a double [BEEP].

Time-of-day function entry three will now activate at the eleventh hour.

The VRC2000 will say

• TIME-OF-DAY MINUTES FOR ENTRY THREE ARE ... {TEN}

You enter

☛ “5 9”

The VRC2000 will respond with a double [BEEP].

Time-of-day function entry three will now activate at the fifty-ninth minute of the selected hour.

The VRC2000 will say

• TIME-OF-DAY SECONDS FOR ENTRY THREE ARE ... {TEN}

You enter

☛ “0 1”

The VRC2000 will respond with a double [BEEP].

Time-of-day function entry three will now activate at the first second of the selected minute and hour.

The VRC2000 will say

- TIME OF DAY FOR ENTRY THREE IS ... {AM}

You enter

☛ “#”

The VRC2000 will respond with a double [BEEP].

Time-of-day function entry three will now activate during the afternoon (PM). In this example, time selected is 11:59:01 p.m.

Use the “#” symbol to program the time-of-day function to activate during the afternoon (PM); the “*” selected AM (before noon) portion of the day.

The VRC2000 will say

- TIME-OF-DAY DATE FOR ENTRY ONE IS ... {OCTOBER}

You enter

☛ “1 1”

The VRC2000 will respond with a double [BEEP].

Time-of-day function entry three will now activate in November.

The VRC2000 will say

- TIME-OF-DAY DAY FOR ENTRY ONE IS ... {TEN}.

You enter

☛ “0 0”

The VRC2000 will respond with a double [BEEP].

Time-of-day function three will now activate every day during the month of November at 11:59:01 p.m.

The “0 0” entry for this parameter programs the VRC2000 to activate the selected command-channel switch every day for the programmed month at the programmed time.

The VRC2000 will say

- COMMAND CHANNEL NUMBER FOR ENTRY ONE IS ... {ONE}

You enter

☛ “0 8”

Appendix G:
Continued 

The VRC2000 will respond with a double [BEEP].

Time-of-day function three will now trigger command channel 8 at 11:59:01 p.m. every day during the month of November.

The VRC2000 will say

- ACTIVE COMMAND CHANNEL SWITCH FOR ENTRY ONE IS ... {A ACTIVATED}

You enter

 “*”

The VRC2000 will respond with a double [BEEP].

Time-of-day function three will now trigger command channel 8’s A switch at 11:59:01 p.m. every day for the month of November.

Exercise 2

Repeat the same steps listed above, only use the disable code (“0 0”) for the time-of-day date function. Then set-up this entry to activate weekly on Wednesday (“0 4”).

Exercise 3

Repeating the same steps listed above, but use the disable code “0” for the day-of-the-week function. This will cause this time-of-day function to activate daily.

Appendix H: Setup
Worksheets 

Worksheet 1: Auto-Logging (☛ "0 2 0")

Logging Start:	Hours (01-12)	_____	_____
Logging Start:	Minutes (00-59)	_____	_____
Logging Start:	(☛ "*" = a.m., ☛ "#" = p.m.)	_____	_____
Logging Stop:	Hours (01-12)	_____	_____
Logging Stop:	Minutes (00-59)	_____	_____
Logging Stop:	(☛ "*" = a.m., ☛ "#" = p.m.)	_____	_____
Logging Repeat:	Hours (01-12)	_____	_____
Logging Repeat:	Minutes (00-59)	_____	_____

☛ "0 2 0 *" = Disable ☛ "0 2 0 #" = Enable/Program

Worksheet 2: Real-Time Clock/Calendar (☛ "0 6 0")

Hours:	_____	_____	Two Digits (01-12)	
Minutes:	_____	_____	Two Digits (00-59)	
Seconds:	_____	_____	Two Digits (00-59)	
Time of Day:	_____		(☛ "*" = a.m., ☛ "#" = p.m.)	
Daylight Savings Time	_____		(☛ "*" = Disabled, ☛ "#" = Enabled)	
Day of Week	_____		1 = Sunday 2 = Monday 3 = Tuesday 4 = Wednesday 5 = Thursday 6 = Friday 7 = Saturday	
Month	_____	_____	Two Digits (01-12)	
Day of Month	_____	_____	Two Digits (01-31)	
Year	_____	_____	_____	Four Digits (1986-2100)

Worksheet 3: Telephone Interface Options Setup (☛ "0 7 0")

Dialing is ...	_____	(☛ "*" = Pulse, ☛ "#" = DTMF)
Ring Count is ...	_____	0-9 Rings (Default is {2})
Inactivity Timer is ...	_____	(☛ "*" = Disabled, ☛ "#" = Enabled)
Dial-Tone Wait is ...	_____	(☛ "*" = Disabled, ☛ "#" = Enabled)

Appendix H:
Continued 

Worksheet 4: System Identifier Setup (☛ “0 8 0”)

	<u>Word Code #</u>	<u>Word</u>	<u>Suggestion</u>
Word # 1	()	_____	• HELLO
Word # 2	()	_____	• THIS
Word # 3	()	_____	• IS
Word # 4	()	_____	
Word # 5	()	_____	
Word # 6	()	_____	
Word # 7	()	_____	
Word # 8	()	_____	
Word # 9	()	_____	
Word # 10	()	_____	
Word # 11	()	_____	
Word # 12	()	_____	
Word # 13	()	_____	
Word # 14	()	_____	
Word # 15	()	_____	
Word # 16	()	_____	
Word # 17	()	_____	• PLEASE
Word # 18	()	_____	• ENTER
Word # 19	()	_____	• ACCESS
Word # 20	()	_____	• CODE

Worksheet 5: Access Codes Setup (☛ “0 9 0”)

Operator Access	Default {0 1 2 3 4}	_____	_____	_____	_____	_____
User Access	Default {1 2 3 4 5}	_____	_____	_____	_____	_____
System Access	Default {1 2 3 4 5 6 7}	_____	_____	_____	_____	_____

Worksheet 6: Outbound Telephone Numbers (☛ “1 0 1” through ☛ “1 0 5”)

<i>Outbound Telephone Numbers</i>	<i>Telephone Number</i> (30 digits maximum) (End entry with #) (* = two-second pause)	<i>Output Configuration</i> (☛ “*” = Phone Voice) (☛ “#” = Phone Modem) (☛ “7” = Radio Voice) (☛ “9” = Radio Modem)	<i>Message-Only Mode</i> (☛ “#” = Enabled) (☛ “*” = Disabled)
☛ “1 0 1 x”	_____	_____	_____
☛ “1 0 1 x”	_____	_____	_____
☛ “1 0 1 x”	_____	_____	_____
☛ “1 0 1 x”	_____	_____	_____
☛ “1 0 1 x”	_____	_____	_____

x = Suffix (= Disable, # = Enable)*

Worksheet 7: Sequence-Output Programs (☛ “5 0 1” through ☛ “5 0 4”)

<i>Sequence Output Program</i>	<i>Digits</i>	<u>1</u>	<u>2</u>	<u>3</u>	<u>4</u>	<u>5</u>	<u>6</u>	<u>7</u>	<u>8</u>	<u>9</u>	<u>10</u>	<u>11</u>	<u>12</u>	<u>13</u>	<u>14</u>	<u>15</u>	<u>16</u>	<u>17</u>	<u>18</u>	<u>19</u>	<u>20</u>	<u>21</u>	<u>22</u>	<u>23</u>	<u>24</u>	<u>25</u>	<u>26</u>	<u>27</u>	<u>28</u>	<u>29</u>	<u>30</u>	<u>31</u>	<u>32</u>
☛ “5 0 1”		-	-	-	-	-	-	-	-	-	-	-	-	-	-	-	-	-	-	-	-	-	-	-	-	-	-	-	-	-	-		
☛ “5 0 2”		-	-	-	-	-	-	-	-	-	-	-	-	-	-	-	-	-	-	-	-	-	-	-	-	-	-	-	-	-	-		
☛ “5 0 3”		-	-	-	-	-	-	-	-	-	-	-	-	-	-	-	-	-	-	-	-	-	-	-	-	-	-	-	-	-	-		
☛ “5 0 4”		-	-	-	-	-	-	-	-	-	-	-	-	-	-	-	-	-	-	-	-	-	-	-	-	-	-	-	-	-	-		

Appendix H:
Continued

1

Worksheet 10:

"201"

W

"2"

Command Channel No.	Channel Identifier		Mode * = Momentary # = Latching	Switch A Identifier		Switch B Identifier		Active Delay (001 to 255)
	(Word #)	(Word #)		(Word #)	(Word #)	(Word #)	(Word #)	
2xx	608	771	*	634	771	529	771	008
201	()	()		()	()	()	()	
202	()	()		()	()	()	()	
203	()	()		()	()	()	()	
204	()	()		()	()	()	()	
205	()	()		()	()	()	()	
206	()	()		()	()	()	()	
207	()	()		()	()	()	()	
208	()	()		()	()	()	()	
209	()	()		()	()	()	()	
210	()	()		()	()	()	()	
211	()	()		()	()	()	()	
212	()	()		()	()	()	()	
213	()	()		()	()	()	()	
214	()	()		()	()	()	()	
215	()	()		()	()	()	()	
216	()	()		()	()	()	()	

xx = command channel (01-16)
Make copies as necessary.



Gentner

Appendix I: Word
List 

Code	Word	Code	Word	Code	Word	Code	Word
000	zero	049	Sunday	100	A	149	in- (rising)
001	one	050	Monday	101	B	150	per-
002	two	051	Tuesday	102	C	151	re- (“restore”)
003	three	052	Wednesday	103	D	152	re- (“replace”)
004	four	053	Thursday	104	E	153	re- (“reset”)
005	five	054	Friday	105	F	154	re- (“receiver”)
006	six	055	Saturday	106	G	155	sub-
007	seven	056	5 ms silence	107	H	156	un- (“unlock”)
008	eight	057	10 ms silence	108	I	157	un- (“untrue”)
009	nine	058	20 ms silence	109	J	158	200 Hz 500 ms
010	minus	059	40 ms silence	110	K	159	200 Hz 50 ms
011	plus	060	80 ms silence	111	L	160	400 Hz 500 ms
012	point	061	160 ms silence	112	M	161	400 Hz 50 ms
013	hundred	062	320 ms silence	113	N	162	800 Hz 500 ms
014	thousand	063	640 ms silence	114	O	163	800 Hz 50 ms
015	million	064	960 ms silence	115	P	164	1000 Hz 500 ms
016	ten	065	January	116	Q	165	1000 Hz 50 ms
017	eleven	066	February	117	R	166	2000 Hz 500 ms
018	twelve	067	March	118	S	167	2000 Hz 50 ms
019	thirteen	068	April	119	T	168	5000 Hz 500 ms
020	fourteen	069	May	120	U	169	5000 Hz 100 ms
021	fifteen	070	June	121	V	170	-
022	sixteen	071	July	122	W	171	-
023	seventeen	072	August	123	X	172	-
024	eighteen	073	September	124	Y	173	-
025	nineteen	074	October	125	Z	174	-
026	AM	075	November	126	-ed (“id”)	175	-
027	PM	076	December	127	-ed (short-”id”)	176	-
028	AC	077	1.3 sec silence	128	-ed (“d”)	177	-
029	dB	078	2 sec silence	129	-ed (“t”)	178	-
030	DC	079	5 sec silence	130	-er (“dollar”)	179	-
031	VA	080	amber	131	-er (“after”)	180	-
032	zero	081	black	132	-er (“lower”)	181	-
033	ten	082	blue	133	-er (“customer”)	182	-
034	twenty	083	brown	134	-er (“lesser”)	183	-
035	thirty	084	gold	135	-ing (“budgeting”)	184	-
036	forty	085	gray	136	-ing (“missing”)	185	-
037	fifty	086	green	137	-ing (“activating”)	186	-
038	sixty	087	orange	138	-ly	187	-
039	seventy	088	pink	139	-s (“s”)	188	-
040	eighty	089	purple	140	-s (“ez”)	189	-
041	ninety	090	red	141	-th	190	-
042	pico-	091	silver	142	-uth	191	-
043	nano-	092	turquoise	143	a- (“a”)	192	-
044	micro-	093	violet	144	a- (short-”uh”)	193	-
045	milli-	094	white	145	a- (“uh”)	194	-
046	centi-	095	yellow	146	de-	195	-
047	kilo-	096	-	147	dis-	196	-
048	mega-	097	STL	148	in- (short)	197	-

Appendix I:

Continued 

<u>Code</u>	<u>Word</u>	<u>Code</u>	<u>Word</u>	<u>Code</u>	<u>Word</u>	<u>Code</u>	<u>Word</u>
200	able	250	authorized	300	change	350	degrees
201	abort	251	auto	301	channel	351	delay
202	aborted	252	automatic	302	check	352	delete
203	above	253	auxiliary	303	checkpoint	353	delta
204	access	254	available	304	choice	354	department
205	acknowledge	255	average	305	circuit	355	depth
206	activate	256	back	306	clear	356	descend
207	activated	257	bad	307	clock	357	detect
208	activating	258	bail-out	308	close	358	detected
209	active	259	bang	309	closed	359	detector
210	additional	260	bars	310	code	360	devise
211	adjust	261	barometric	311	coil	361	dial
212	advise	262	base	312	cold	362	dialed
213	advisory	263	base-current	313	combiner	363	dialing
214	affirm	264	bath	314	command	364	did
215	after	265	battery	315	common	365	diesel
216	afternoon	266	baud	316	communication	366	dip
217	again	267	be	317	complete	367	direct
218	ahead	268	bearing	318	composition	368	direction
219	air	269	before	319	compressor	369	diisable
220	aircraft	270	behind	320	computer	370	disabled
221	adjust	271	bell	321	condition	371	disarm
222	alarm	272	below	322	conductivity	372	discharge
223	alert	273	blank	323	conference	373	disconnect
224	all	274	blocking	324	configuration	374	disengage
225	allied	275	booster	325	confirmed	375	display
226	alternate	276	box	326	connect	376	divide
227	altitude	277	brake	327	constant	377	division
228	am	278	bright	328	consumption	378	do
229	Amps	279	building	329	contact	379	door
230	Amperes	280	burst	330	control	380	double
231	an	281	busy	331	converter	381	down
232	and	282	button	332	cool	382	drive
233	angle	283	buzzer	333	coolant	383	dumb
234	announcement	284	by	334	coordinates	384	dummy
235	answer	285	calibrate	335	correct	385	duplex
236	antenna	286	calibration	336	count	386	earth
237	approaching	287	call	337	crash	387	east
238	are	288	calling	338	cross	388	echo
239	area	289	cancel	339	cubic	389	efficiency
240	armed	290	cap	340	current	390	elapsed
241	arrival	291	capacitance	341	damage	391	electric
242	as	292	capacitor	342	danger	392	electricity
243	ascend	293	car	343	dark	393	emergency
244	ask	294	carrier	344	data	394	empty
245	assign	295	case	345	date	395	enable
246	at	296	caution	346	day	396	enabled
247	attack	297	Celsius	347	decimal	397	end
248	attention	298	center	348	decrease	398	energy
249	audio	299	centigrade	349	default	399	engage

<u>Code</u>	<u>Word</u>	<u>Code</u>	<u>Word</u>	<u>Code</u>	<u>Word</u>	<u>Code</u>	<u>Word</u>
400	enter	450	good	500	key	550	mono
401	entry	451	good-bye	501	kill	551	more
402	equal	452	grams	502	knots	552	morning
403	equipment	453	great	503	large	553	motor
404	erase	454	greater	504	last	554	move
405	erased	455	greater-than	505	leak	555	music
406	error	456	ground	506	leakage	556	near
407	escape	457	group	507	leave	557	negate
408	evening	458	half	508	left	558	neutral
409	exit	459	hard	509	less	559	next
410	exterior	460	has	510	less-than	560	night
411	external	461	have	511	level	561	no
412	extreme	462	head-end	512	light	562	none
413	fade	463	heading	513	lights	563	normal
414	Fahrenheit	464	hello	514	limit	564	north
415	failed	465	help	515	line	565	not
416	failure	466	here	516	line-feed	566	notice
417	fan	467	Hertz	517	link	567	now
418	Farads	468	high	518	listen	568	number
419	fast	469	higher	519	load	569	of
420	faster	470	hold	520	local	570	off
421	fault	471	home	521	lock	571	oh
422	feet	472	hook	522	locked	572	Ohms
423	field	473	horizontal	523	logging	573	okay
424	filament	474	hot	524	long	574	old
425	fire	475	hours	525	loop	575	on
426	fire (excited)	476	house	526	loop-current	576	only
427	first	477	identification	527	looped	577	open
428	flash	478	identifier	528	low	578	operator
429	flooded	479	idle	529	lower	579	optical
430	floor	480	if	530	main	580	or
431	flow	481	immediate	531	maintain	581	order
432	for	482	in	532	mark	582	originate
433	forward	483	input	533	marker	583	other
434	forwarded	484	inactive	534	match	584	out
435	free	485	inbound	535	may-day	585	output
436	freeze	486	inches	536	medium	586	outside
437	freezer	487	incorrect	537	message	587	over
438	frequency	488	increase	538	meter	588	over-range
439	from	489	inductor	539	meters	589	page
440	front	490	insert	540	metering	590	pair
441	fuel	491	instruction	541	micro	591	pan
442	function	492	interface	542	microphone	592	panic
443	furnace	493	interrupt	543	microwave	593	parallel
444	fuse	494	intruder	544	mike	594	pass
445	fused	495	intrusion	545	miles	595	passed
446	gallons	496	invalid	546	minutes	596	peak
447	gas	497	is	547	modem	597	pending
448	generator	498	isolation	548	module	598	per
449	go	499	junction	549	monitor	599	percent

Appendix I:

Continued 

<u>Code</u>	<u>Word</u>	<u>Code</u>	<u>Word</u>	<u>Code</u>	<u>Word</u>	<u>Code</u>	<u>Word</u>
600	period	650	repeat	700	station	750	unbalanced
601	phase	651	report	701	status	751	understood
602	phase-angle	652	request	702	stereo	752	unit
603	phone	653	reset	703	stop	753	unknown
604	pick	654	resistance	704	storage	754	unlock
605	pickup	655	resistor	705	strobe	755	unlocked
606	place	656	response	706	studio	756	untrue
607	plant	657	restore	707	subscriber	757	up
608	plate	658	restored	708	supervisory	758	use
609	play	659	resuming	709	supply	759	user
610	please	660	return	710	surface	760	used
611	police	661	reverse	711	switch	761	utility
612	port	662	right	712	switched	762	vaccum
613	position	663	ring	713	system	763	valve
614	post	664	room	714	tank	764	vehicle
615	pounds	665	running	715	tape	765	vertical
616	power	666	save	716	taping	766	very
617	present	667	screen	717	temperature	767	video
618	pressure	668	search	718	terminate	768	visual
619	priority	669	second	719	terminated	769	voice
620	proceed	670	seconds	720	test	770	volt
621	program	671	secure	721	thank-you	771	voltage
622	pull	672	security	722	the	772	volts
623	pulse	673	select	723	thee	773	wait
624	pulses	674	send	724	therms	774	warm
625	pump	675	sensor	725	thermal	775	warning
626	push	676	sequence	726	this	776	was
627	put	677	serial	727	time	777	water
628	quarter	678	service	728	today	778	Watts
629	question	679	set	729	told	779	wave
630	radar	680	short	730	tone	780	way
631	radial	681	shut	731	total	781	week
632	radio	682	side	732	tower	782	welcome
633	rain	683	signal	733	track	783	well
634	raise	684	single	734	tracking	784	west
635	range	685	site	735	traffic	785	why
636	rate	686	slow	736	transfer	786	wind (noun)
637	reading	687	slower	737	transferred	787	wind (verb)
638	ready	688	small	738	transformer	788	window
639	received	689	smoke	739	transmitter	789	wish
640	receiver	690	sorry	740	trip	790	with
641	reconnect	691	sound	741	tripped	791	within
642	record	692	south	742	true	792	word
643	recorded	693	space	743	trunk	793	working
644	reflected	694	spare	744	turn	794	wrong
645	release	695	speed	745	turned	795	yes
646	relief	696	square	746	type	796	you
647	remote	697	standby	747	unable	797	your
648	removed	698	start	748	unattended	798	yours
649	repair	699	state	749	unbalance	799	zone



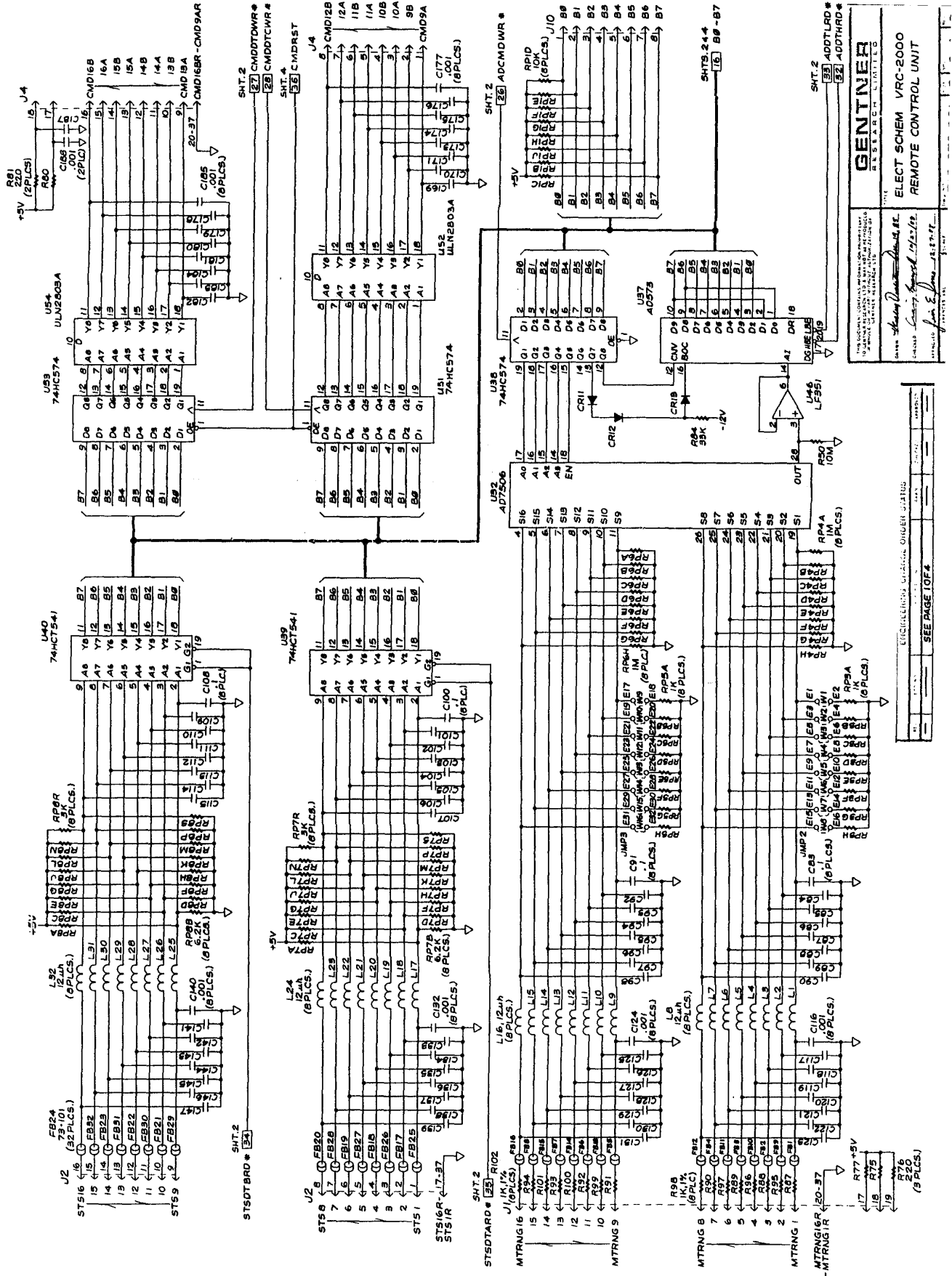

GENTNER
RESEARCH LIMITED

ELECT SCHEM VRC-2000
REMOTE CONTROL UNIT

DATE: *Shawn P. Jones, 10/20/88*
DESIGNED BY: *Shawn P. Jones, 10/20/88*
DRAWN BY: *Shawn P. Jones, 10/20/88*

SEE PAGE TOP #

REVISIONS

NO.	DESCRIPTION	DATE

ENGINEERING CHANGE ORDER STATUS			
REV.	LOG NO.	DESCRIPTION	APPROVED
A		PRODUCTION RELEASE	
B		WT AMENDED	
C		NON FUNCTIONAL DATA REMOVED	
		UPDATED TO VRC-2000 SPEC.	

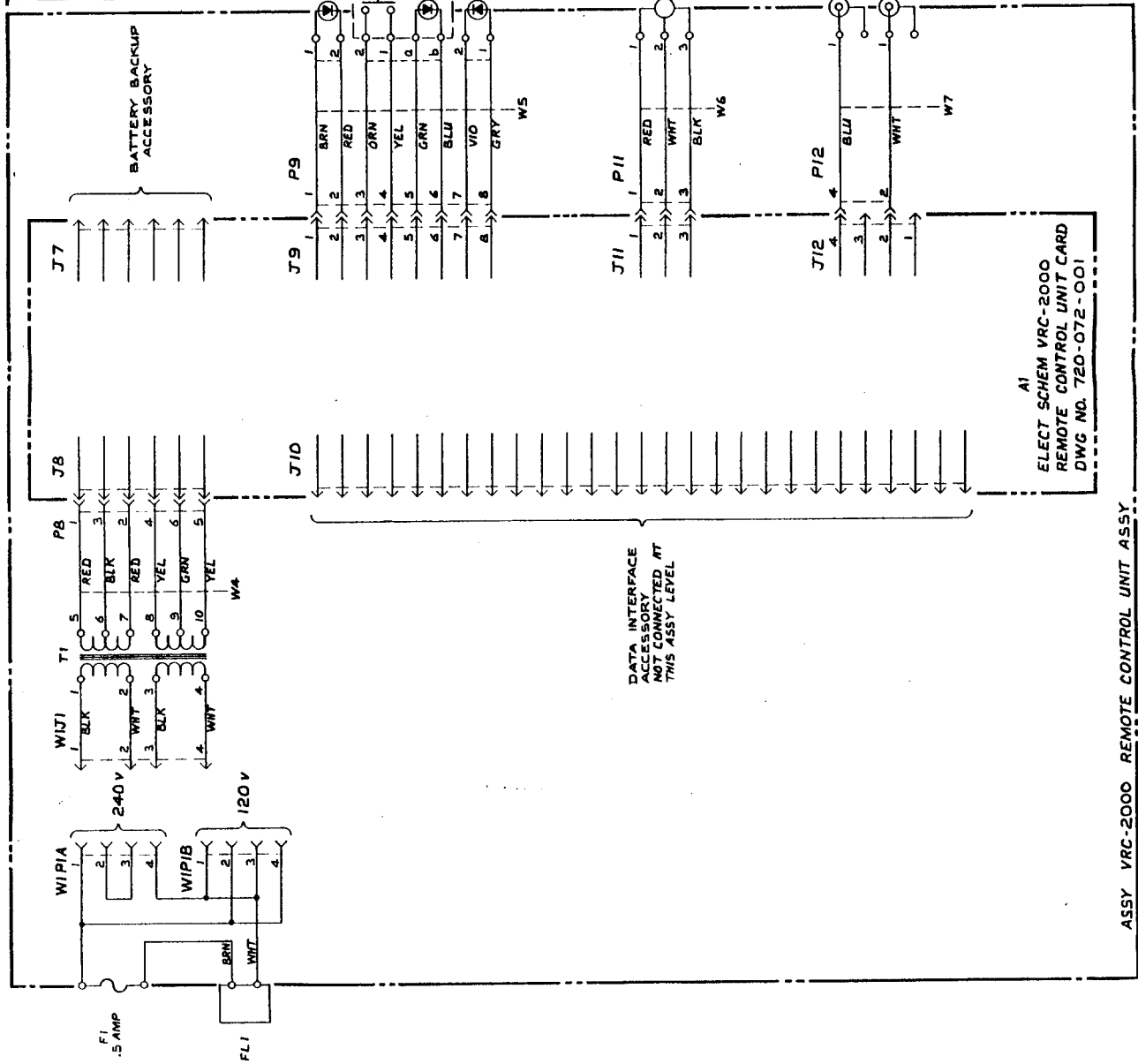

GENTNER RESEARCH LIMITED		TITLE	
INT DIAGRAM VRC-2000 REMOTE CONTROL UNIT		REV. 1 of 1	
DATE: 07/05/88		DRAWN BY: J. E. HARRIS	
CHECKED BY: J. E. HARRIS		DATE: 12/17/88	
APPROVED BY: J. E. HARRIS		DATE: 12/17/88	
PART NO. 710-072-002		REV. D	

VRC2000 Notes